

Programmable Controller

MELSEC iQ-R
series

MELSEC iQ-R High Speed Digital-Analog
Converter Module
User's Manual (Startup)

-R60DAH4



SAFETY PRECAUTIONS

(Read these precautions before using this product.)

Before using this product, please read this manual and the relevant manuals carefully and pay full attention to safety to handle the product correctly.

The precautions given in this manual are concerned with this product only. For the safety precautions of the programmable controller system, refer to the MELSEC iQ-R Module Configuration Manual.

In this manual, the safety precautions are classified into two levels: "⚠️ WARNING" and "⚠️ CAUTION".

 WARNING	Indicates that incorrect handling may cause hazardous conditions, resulting in death or severe injury.
 CAUTION	Indicates that incorrect handling may cause hazardous conditions, resulting in minor or moderate injury or property damage.

Under some circumstances, failure to observe the precautions given under "⚠️ CAUTION" may lead to serious consequences.

Observe the precautions of both levels because they are important for personal and system safety.

Make sure that the end users read this manual and then keep the manual in a safe place for future reference.

[Design Precautions]

WARNING

- Configure safety circuits external to the programmable controller to ensure that the entire system operates safely even when a fault occurs in the external power supply or the programmable controller. Failure to do so may result in an accident due to an incorrect output or malfunction.
 - (1) Emergency stop circuits, protection circuits, and protective interlock circuits for conflicting operations (such as forward/reverse rotations or upper/lower limit positioning) must be configured external to the programmable controller.
 - (2) When the programmable controller detects an abnormal condition, it stops the operation and all outputs are:
 - Turned off if the overcurrent or overvoltage protection of the power supply module is activated.
 - Held or turned off according to the parameter setting if the self-diagnostic function of the CPU module detects an error such as a watchdog timer error.
 - (3) All outputs may be turned on if an error occurs in a part, such as an I/O control part, where the CPU module cannot detect any error. To ensure safety operation in such a case, provide a safety mechanism or a fail-safe circuit external to the programmable controller. For a fail-safe circuit example, refer to "General Safety Requirements" in the MELSEC iQ-R Module Configuration Manual.
 - (4) Outputs may remain on or off due to a failure of a component such as a relay and transistor in an output circuit. Configure an external circuit for monitoring output signals that could cause a serious accident.
 - In an output circuit, when a load current exceeding the rated current or an overcurrent caused by a load short-circuit flows for a long time, it may cause smoke and fire. To prevent this, configure an external safety circuit, such as a fuse.
 - Configure a circuit so that the programmable controller is turned on first and then the external power supply. If the external power supply is turned on first, an accident may occur due to an incorrect output or malfunction.
 - For the operating status of each station after a communication failure, refer to manuals relevant to the network. Incorrect output or malfunction due to a communication failure may result in an accident.
 - When connecting an external device with a CPU module or intelligent function module to modify data of a running programmable controller, configure an interlock circuit in the program to ensure that the entire system will always operate safely. For other forms of control (such as program modification, parameter change, forced output, or operating status change) of a running programmable controller, read the relevant manuals carefully and ensure that the operation is safe before proceeding. Improper operation may damage machines or cause accidents.
 - Especially, when a remote programmable controller is controlled by an external device, immediate action cannot be taken if a problem occurs in the programmable controller due to a communication failure. To prevent this, configure an interlock circuit in the program, and determine corrective actions to be taken between the external device and CPU module in case of a communication failure.
 - Do not write any data to the "system area" and "write-protect area" of the buffer memory in the module. Also, do not use any "use prohibited" signals as an output signal from the CPU module to each module. Doing so may cause malfunction of the programmable controller system. For the "system area", "write-protect area", and the "use prohibited" signals, refer to the user's manual for the module used.
-

[Design Precautions]

WARNING

- If a communication cable is disconnected, the network may be unstable, resulting in a communication failure of multiple stations. Configure an interlock circuit in the program to ensure that the entire system will always operate safely even if communications fail. Failure to do so may result in an accident due to an incorrect output or malfunction.
 - To maintain the safety of the programmable controller system against unauthorized access from external devices via the network, take appropriate measures. To maintain the safety against unauthorized access via the Internet, take measures such as installing a firewall.
 - Analog outputs may remain on due to a failure of the module. Configure an external interlock circuit for output signals that could cause a serious accident.
-

[Design Precautions]

CAUTION

- Do not install the control lines or communication cables together with the main circuit lines or power cables. Keep a distance of 100mm or more between them. Failure to do so may result in malfunction due to noise.
 - During control of an inductive load such as a lamp, heater, or solenoid valve, a large current (approximately ten times greater than normal) may flow when the output is turned from off to on. Therefore, use a module that has a sufficient current rating.
 - After the CPU module is powered on or is reset, the time taken to enter the RUN status varies depending on the system configuration, parameter settings, and/or program size. Design circuits so that the entire system will always operate safely, regardless of the time.
 - Do not power off the programmable controller or reset the CPU module while the settings are being written. Doing so will make the data in the flash ROM undefined. The values need to be set in the buffer memory and written to the flash ROM again. Doing so also may cause malfunction or failure of the module.
 - When changing the operating status of the CPU module from external devices (such as the remote RUN/STOP functions), select "Do Not Open by Program" for "Open Method" of "Module Parameter". If "Open by Program" is selected, an execution of the remote STOP function causes the communication line to close. Consequently, the CPU module cannot reopen the line, and external devices cannot execute the remote RUN function.
 - Power on or off the external power supply while the programmable controller is on. Failure to do so may result in incorrect output or malfunction.
 - At on/off of the power or external power supply, or at the output range switching, a voltage may occur or a current may flow between output terminals for a moment. In this case, start the control after analog outputs become stable.
-

[Installation Precautions]

WARNING

- Shut off the external power supply (all phases) used in the system before mounting or removing the module. Failure to do so may result in electric shock or cause the module to fail or malfunction.
-

[Installation Precautions]

CAUTION

- Use the programmable controller in an environment that meets the general specifications in the Safety Guidelines included with the base unit. Failure to do so may result in electric shock, fire, malfunction, or damage to or deterioration of the product.
 - To mount a module, place the concave part(s) located at the bottom onto the guide(s) of the base unit, and push in the module until the hook(s) located at the top snaps into place. Incorrect interconnection may cause malfunction, failure, or drop of the module.
 - When using the programmable controller in an environment of frequent vibrations, fix the module with a screw.
 - Tighten the screws within the specified torque range. Undertightening can cause drop of the screw, short circuit, or malfunction. Overtightening can damage the screw and/or module, resulting in drop, short circuit, or malfunction.
 - When using an extension cable, connect it to the extension cable connector of the base unit securely. Check the connection for looseness. Poor contact may cause malfunction.
 - When using an SD memory card, fully insert it into the SD memory card slot. Check that it is inserted completely. Poor contact may cause malfunction.
 - Securely insert an extended SRAM cassette into the cassette connector of the CPU module. After insertion, close the cassette cover and check that the cassette is inserted completely. Poor contact may cause malfunction.
 - Do not directly touch any conductive parts and electronic components of the module, SD memory card, extended SRAM cassette, or connector. Doing so can cause malfunction or failure of the module.
-

[Wiring Precautions]

WARNING

- Shut off the external power supply (all phases) used in the system before installation and wiring. Failure to do so may result in electric shock or cause the module to fail or malfunction.
 - After installation and wiring, attach the included terminal cover to the module before turning it on for operation. Failure to do so may result in electric shock.
-

[Wiring Precautions]

CAUTION

- Individually ground the FG and LG terminals of the programmable controller with a ground resistance of 100 ohms or less. Failure to do so may result in electric shock or malfunction.
 - Use applicable solderless terminals and tighten them within the specified torque range. If any spade solderless terminal is used, it may be disconnected when the terminal screw comes loose, resulting in failure.
 - Check the rated voltage and signal layout before wiring to the module, and connect the cables correctly. Connecting a power supply with a different voltage rating or incorrect wiring may cause fire or failure.
 - Connectors for external devices must be crimped or pressed with the tool specified by the manufacturer, or must be correctly soldered. Incomplete connections may cause short circuit, fire, or malfunction.
 - Securely connect the connector to the module. Poor contact may cause malfunction.
 - Do not install the control lines or communication cables together with the main circuit lines or power cables. Keep a distance of 100mm or more between them. Failure to do so may result in malfunction due to noise.
 - Place the cables in a duct or clamp them. If not, dangling cable may swing or inadvertently be pulled, resulting in damage to the module or cables or malfunction due to poor contact. Do not clamp the extension cables with the jacket stripped. Doing so may change the characteristics of the cables, resulting in malfunction.
 - Check the interface type and correctly connect the cable. Incorrect wiring (connecting the cable to an incorrect interface) may cause failure of the module and external device.
 - Tighten the terminal screws or connector screws within the specified torque range. Undertightening can cause drop of the screw, short circuit, fire, or malfunction. Overtightening can damage the screw and/or module, resulting in drop, short circuit, fire, or malfunction.
 - When disconnecting the cable from the module, do not pull the cable by the cable part. For the cable with connector, hold the connector part of the cable. For the cable connected to the terminal block, loosen the terminal screw. Pulling the cable connected to the module may result in malfunction or damage to the module or cable.
 - Prevent foreign matter such as dust or wire chips from entering the module. Such foreign matter can cause a fire, failure, or malfunction.
 - A protective film is attached to the top of the module to prevent foreign matter, such as wire chips, from entering the module during wiring. Do not remove the film during wiring. Remove it for heat dissipation before system operation.
 - Programmable controllers must be installed in control panels. Connect the main power supply to the power supply module in the control panel through a relay terminal block. Wiring and replacement of a power supply module must be performed by qualified maintenance personnel with knowledge of protection against electric shock. For wiring, refer to the MELSEC iQ-R Module Configuration Manual.
 - For Ethernet cables to be used in the system, select the ones that meet the specifications in the user's manual for the module used. If not, normal data transmission is not guaranteed.
-

[Startup and Maintenance Precautions]

WARNING

- Do not touch any terminal while power is on. Doing so will cause electric shock or malfunction.
 - Correctly connect the battery connector. Do not charge, disassemble, heat, short-circuit, solder, or throw the battery into the fire. Also, do not expose it to liquid or strong shock. Doing so will cause the battery to produce heat, explode, ignite, or leak, resulting in injury and fire.
 - Shut off the external power supply (all phases) used in the system before cleaning the module or retightening the terminal screws, connector screws, or module fixing screws. Failure to do so may result in electric shock.
-

[Startup and Maintenance Precautions]

CAUTION

- When connecting an external device with a CPU module or intelligent function module to modify data of a running programmable controller, configure an interlock circuit in the program to ensure that the entire system will always operate safely. For other forms of control (such as program modification, parameter change, forced output, or operating status change) of a running programmable controller, read the relevant manuals carefully and ensure that the operation is safe before proceeding. Improper operation may damage machines or cause accidents.
 - Especially, when a remote programmable controller is controlled by an external device, immediate action cannot be taken if a problem occurs in the programmable controller due to a communication failure. To prevent this, configure an interlock circuit in the program, and determine corrective actions to be taken between the external device and CPU module in case of a communication failure.
 - Do not disassemble or modify the modules. Doing so may cause failure, malfunction, injury, or a fire.
 - Use any radio communication device such as a cellular phone or PHS (Personal Handy-phone System) more than 25cm away in all directions from the programmable controller. Failure to do so may cause malfunction.
 - Shut off the external power supply (all phases) used in the system before mounting or removing the module. Failure to do so may cause the module to fail or malfunction.
 - Tighten the screws within the specified torque range. Undertightening can cause drop of the component or wire, short circuit, or malfunction. Overtightening can damage the screw and/or module, resulting in drop, short circuit, or malfunction.
 - After the first use of the product, do not mount/remove the module to/from the base unit, and the terminal block to/from the module, and do not insert/remove the extended SRAM cassette to/from the CPU module more than 50 times (IEC 61131-2 compliant) respectively. Exceeding the limit may cause malfunction.
 - After the first use of the product, do not insert/remove the SD memory card to/from the CPU module more than 500 times. Exceeding the limit may cause malfunction.
 - Do not touch the metal terminals on the back side of the SD memory card. Doing so may cause malfunction or failure of the module.
 - Do not touch the integrated circuits on the circuit board of an extended SRAM cassette. Doing so may cause malfunction or failure of the module.
 - Do not drop or apply shock to the battery to be installed in the module. Doing so may damage the battery, causing the battery fluid to leak inside the battery. If the battery is dropped or any shock is applied to it, dispose of it without using.
 - Startup and maintenance of a control panel must be performed by qualified maintenance personnel with knowledge of protection against electric shock. Lock the control panel so that only qualified maintenance personnel can operate it.
 - Before handling the module, touch a conducting object such as a grounded metal to discharge the static electricity from the human body. Failure to do so may cause the module to fail or malfunction.
-

[Operating Precautions]

CAUTION

- When changing data and operating status, and modifying program of the running programmable controller from an external device such as a personal computer connected to an intelligent function module, read relevant manuals carefully and ensure the safety before operation. Incorrect change or modification may cause system malfunction, damage to the machines, or accidents.
 - Do not power off the programmable controller or reset the CPU module while the setting values in the buffer memory are being written to the flash ROM in the module. Doing so will make the data in the flash ROM undefined. The values need to be set in the buffer memory and written to the flash ROM again. Doing so can cause malfunction or failure of the module.
-

[Disposal Precautions]

CAUTION

- When disposing of this product, treat it as industrial waste.
 - When disposing of batteries, separate them from other wastes according to the local regulations. For details on battery regulations in EU member states, refer to the MELSEC iQ-R Module Configuration Manual.
-

[Transportation Precautions]

CAUTION

- When transporting lithium batteries, follow the transportation regulations. For details on the regulated models, refer to the MELSEC iQ-R Module Configuration Manual.
 - The halogens (such as fluorine, chlorine, bromine, and iodine), which are contained in a fumigant used for disinfection and pest control of wood packaging materials, may cause failure of the product. Prevent the entry of fumigant residues into the product or consider other methods (such as heat treatment) instead of fumigation. The disinfection and pest control measures must be applied to unprocessed raw wood.
-

CONDITIONS OF USE FOR THE PRODUCT

(1) Mitsubishi programmable controller ("the PRODUCT") shall be used in conditions;

- i) where any problem, fault or failure occurring in the PRODUCT, if any, shall not lead to any major or serious accident; and
- ii) where the backup and fail-safe function are systematically or automatically provided outside of the PRODUCT for the case of any problem, fault or failure occurring in the PRODUCT.

(2) The PRODUCT has been designed and manufactured for the purpose of being used in general industries.

MITSUBISHI SHALL HAVE NO RESPONSIBILITY OR LIABILITY (INCLUDING, BUT NOT LIMITED TO ANY AND ALL RESPONSIBILITY OR LIABILITY BASED ON CONTRACT, WARRANTY, TORT, PRODUCT LIABILITY) FOR ANY INJURY OR DEATH TO PERSONS OR LOSS OR DAMAGE TO PROPERTY CAUSED BY the PRODUCT THAT ARE OPERATED OR USED IN APPLICATION NOT INTENDED OR EXCLUDED BY INSTRUCTIONS, PRECAUTIONS, OR WARNING CONTAINED IN MITSUBISHI'S USER, INSTRUCTION AND/OR SAFETY MANUALS, TECHNICAL BULLETINS AND GUIDELINES FOR the PRODUCT.

("Prohibited Application")

Prohibited Applications include, but not limited to, the use of the PRODUCT in;

- Nuclear Power Plants and any other power plants operated by Power companies, and/or any other cases in which the public could be affected if any problem or fault occurs in the PRODUCT.
- Railway companies or Public service purposes, and/or any other cases in which establishment of a special quality assurance system is required by the Purchaser or End User.
- Aircraft or Aerospace, Medical applications, Train equipment, transport equipment such as Elevator and Escalator, Incineration and Fuel devices, Vehicles, Manned transportation, Equipment for Recreation and Amusement, and Safety devices, handling of Nuclear or Hazardous Materials or Chemicals, Mining and Drilling, and/or other applications where there is a significant risk of injury to the public or property.

Notwithstanding the above, restrictions Mitsubishi may in its sole discretion, authorize use of the PRODUCT in one or more of the Prohibited Applications, provided that the usage of the PRODUCT is limited only for the specific applications agreed to by Mitsubishi and provided further that no special quality assurance or fail-safe, redundant or other safety features which exceed the general specifications of the PRODUCTS are required. For details, please contact the Mitsubishi representative in your region.

INTRODUCTION

Thank you for purchasing the Mitsubishi Electric MELSEC iQ-R series programmable controllers.

This manual describes the performance specifications, procedures before operation, wiring, and operation examples of the relevant product listed below.

Before using this product, please read this manual and the relevant manuals carefully and develop familiarity with the functions and performance of the MELSEC iQ-R series programmable controller to handle the product correctly.

When applying the program examples provided in this manual to an actual system, ensure the applicability and confirm that it will not cause system control problems.

Please make sure that the end users read this manual.

Point

Unless otherwise specified, this manual provides program examples in which the I/O numbers of X/Y0 to X/YF are assigned to the D/A converter module. Assign I/O numbers when applying the program examples to an actual system. For I/O number assignment, refer to the following.

 MELSEC iQ-R Module Configuration Manual



Relevant product

R60DAH4

COMPLIANCE WITH EMC AND LOW VOLTAGE DIRECTIVES

Method of ensuring compliance

To ensure that Mitsubishi programmable controllers maintain EMC and Low Voltage Directives when incorporated into other machinery or equipment, certain measures may be necessary. Please refer to one of the following manuals.

-  MELSEC iQ-R Module Configuration Manual
-  Safety Guidelines (This manual is included with the base unit.)

The CE mark on the side of the programmable controller indicates compliance with EMC and Low Voltage Directives.

Additional measures

No additional measures are necessary for the compliance of this product with EMC and Low Voltage Directives.

CONTENTS

SAFETY PRECAUTIONS	1
CONDITIONS OF USE FOR THE PRODUCT	9
INTRODUCTION	9
COMPLIANCE WITH EMC AND LOW VOLTAGE DIRECTIVES	10
RELEVANT MANUALS	12
TERMS	12
MANUAL PAGE ORGANIZATION	13
CHAPTER 1 PART NAMES	15
CHAPTER 2 SPECIFICATIONS	17
2.1 Performance Specifications	17
CHAPTER 3 FUNCTION LIST	19
CHAPTER 4 PROCEDURES BEFORE OPERATION	21
CHAPTER 5 WIRING	23
5.1 Terminal Block	23
5.2 External Wiring	24
CHAPTER 6 OPERATION EXAMPLES	26
6.1 Programming Procedure	26
6.2 Program Example (for Normal Output Mode)	27
6.3 Program Example (for Wave Output Mode)	31
CHAPTER 7 OFFSET/GAIN SETTING	40
APPENDICES	45
Appendix 1 I/O Conversion Characteristics	45
Appendix 2 Accuracy	48
Appendix 3 Output Response Time	49
Appendix 4 External Dimensions	50
INDEX	52
REVISIONS	54
WARRANTY	55
TRADEMARKS	56

RELEVANT MANUALS

Manual name [manual number]	Description	Available form
MELSEC iQ-R High Speed Digital-Analog Converter Module User's Manual (Startup) [SH-081655ENG] (this manual)	Specifications, procedures before operation, wiring, operation examples, and offset/gain setting of the D/A converter module	Print book e-Manual PDF
MELSEC iQ-R High Speed Digital-Analog Converter Module User's Manual (Application) [SH-081657ENG]	Functions, parameter settings, troubleshooting, I/O signals, and buffer memory of the D/A converter module	Print book e-Manual PDF
MELSEC iQ-R Programming Manual (Instructions, Standard Functions/Function Blocks) [SH-081266ENG]	Instructions for the CPU module, dedicated instructions for the intelligent function modules, and standard functions/function blocks	e-Manual PDF

This manual does not include detailed information on the following:

- General specifications
- Applicable combinations of CPU modules and the other modules, and the number of mountable modules
- Installation

For details, refer to the following.

 MELSEC iQ-R Module Configuration Manual

This manual does not include information on the module function blocks.

For details, refer to the Function Block Reference for the module used.

Point

e-Manual refers to the Mitsubishi Electric FA electronic book manuals that can be browsed using a dedicated tool.

e-Manual has the following features:

- Required information can be cross-searched in multiple manuals.
- Other manuals can be accessed from the links in the manual.
- The hardware specifications of each part can be found from the product figures.
- Pages that users often browse can be bookmarked.

TERMS

Unless otherwise specified, this manual uses the following terms.

Term	Description
Buffer memory	A memory in an intelligent function module for storing data (such as setting values and monitored values) to be transferred to the CPU module
D/A converter module	The abbreviation for the MELSEC iQ-R series high speed digital-analog converter module
Engineering tool	Another term for GX Works3
Factory default setting	A generic term for analog output ranges of 4 to 20mA, 0 to 20mA, 1 to 5V, 0 to 5V, -10 to 10V.
Global label	A label that is valid for all the program data when multiple program data are created in the project. The global label has two types: a module specific label (module label), which is generated automatically by GX Works3, and an optional label, which can be created for any specified device.
GX Works3	The product name of the software package for the MELSEC programmable controllers
Module label	A label that represents one of memory areas (I/O signals and buffer memory areas) specific to each module in a given character string. For the module used, GX Works3 automatically generates this label, which can be used as a global label.
Offset/gain setting mode	This mode is for configuring the offset/gain setting.
Remote head module	The abbreviation for the RJ72GF15-T2 CC-Link IE Field Network remote head module.
User range	An analog output range where any value can be set. This range can be set in the offset/gain setting.
Watchdog timer error	An error that occurs if the internal processing of the D/A converter module is abnormal. Watchdog timer enables the module to monitor its own internal processing.

MANUAL PAGE ORGANIZATION

In this manual, pages about functions, I/O signals, and buffer memory areas are organized and the symbols are used as shown below.

The following illustration is for explanation purpose only, and should not be referred to as an actual documentation.

1.6 Analog Output Test Function When the CPU Module is in STOP State

Normal
High speed
Synchronization

This function allows performing the analog output test when the CPU module is in the STOP state.

Operation

By forcibly turning on 'CH1 Output enable/disable flag' (Y1) when the CPU module is in the STOP state, the analog output value is changed from the offset value to the D/A-converted analog output value. Hereafter, when 'CH1 Digital value' (UnIG460) or 'CH1 Synchronization digital value' (UnIG9500) is updated, the analog output value is updated as well. The following figure shows the relation between 'CH1 Output enable/disable flag' (Y1) and the analog output value of the CPU module in the STOP state when 'Analog Output HOLD/CLEAR Setting' is set to 'CLEAR'.

CPU module status: RUN, STOP, RUN
 CH1 Output enable/disable flag (Y1): OFF, ON, OFF, ON
 Analog output value status: Offset value, Analog output value converted from digital value, Offset value, Analog output value converted from digital value

-----> Performed by the D/A converter module
 -----> Performed by a program

(1) 'CH1 Output enable/disable flag' (Y1) turns off when the state of the CPU module is changed into STOP, and the offset value is output in analog.
 (2) By forcibly turning on 'CH1 Output enable/disable flag' (Y1), the analog output value is changed from the offset value to the D/A-converted analog output value.
 (3) At this time, when 'CH1 Digital value' (UnIG460) or 'CH1 Synchronization digital value' (UnIG9500) is changed, the analog output can be tested.

Enabled functions

The settings of the following functions are enabled during the analog output test.

Normal

- Scaling function
- Shift function
- Warning output function
- Rate control function

Synchronization

- Warning output function

12 1 FUNCTIONS
1.6 Analog Output Test Function When the CPU Module is in STOP State

① The following table lists the operation modes of the D/A converter module in which the corresponding functions and buffer memory areas can be used. Each icon indicates an operation mode as follows.

Icon	Description
<div style="background-color: #333; color: white; padding: 5px; border-radius: 5px; display: inline-block;">Common</div>	The corresponding functions and buffer memory areas can be used in all the operation modes.
<div style="background-color: #333; color: white; padding: 5px; border-radius: 5px; display: inline-block;">High speed</div>	The corresponding functions and buffer memory areas can be used in the high-speed output mode (conversion speed: 1μs/CH).
<div style="background-color: #333; color: white; padding: 5px; border-radius: 5px; display: inline-block;">Normal</div>	The corresponding functions and buffer memory areas can be used in the normal output mode (conversion speed: 10μs/CH).
<div style="background-color: #333; color: white; padding: 5px; border-radius: 5px; display: inline-block;">Wave</div>	The corresponding functions and buffer memory areas can be used in the wave output mode (conversion speed: 20μs/CH).
<div style="background-color: #333; color: white; padding: 5px; border-radius: 5px; display: inline-block;">Synchronization</div>	The corresponding functions and buffer memory areas can be used in the inter-module synchronization mode.

MEMO

1 PART NAMES

This chapter describes the part names of the D/A converter module.

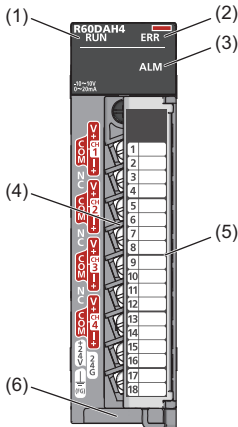

No.	Name	Description
(1)	RUN LED	Indicates the operating status of the module. On: Normal operation Flashing (1s cycles): In offset/gain setting mode Flashing (400ms cycles): Selected as a module for the online module change Off: 5V power supply interrupted, watchdog timer error occurred, or module replacement allowed in the process of the online module change
(2)	ERR LED	Indicates the error status of the module.*1 On: Error occurred Off: Normal operation
(3)	ALM LED	Indicates the alarm status of the module.*1 On: Alarm occurred Off: Normal operation
(4)	Terminal block	18-point screw terminal block. It is used to connect output signal wires to external devices and others.
(5)	Terminal block cover	Covers for preventing electric shock while the power is on
(6)	Production information marking	Shows the production information (16 digits) of the module.

*1 For details, refer to the following.

- 📖 MELSEC iQ-R High Speed Digital-Analog Converter Module User's Manual (Application)

MEMO

2 SPECIFICATIONS

This chapter describes the performance specifications.

2.1 Performance Specifications

2

This section describes the performance specifications of the D/A converter module.

Item		Specifications																								
Number of analog output channels		4 channels																								
Digital input		16-bit signed binary value (-32768 to 32767)																								
Analog output voltage		-10 to 10VDC (external load resistance value 1k Ω or higher) 0 to 5VDC (external load resistance value 500 Ω or higher)																								
Analog output current		0 to 20mA (external load resistance value 50 to 600 Ω)																								
I/O characteristics, resolution ^{*1}		<table border="1"> <thead> <tr> <th colspan="2">Analog output range</th> <th>Digital value</th> <th>Resolution</th> </tr> </thead> <tbody> <tr> <td rowspan="4">Voltage</td> <td>0 to 5V</td> <td rowspan="2">0 to 32000</td> <td>156.3μV</td> </tr> <tr> <td>1 to 5V</td> <td>125.0μV</td> </tr> <tr> <td>-10 to 10V</td> <td rowspan="2">-32000 to 32000</td> <td>312.5μV</td> </tr> <tr> <td>User range setting (voltage)</td> <td>312.5μV^{*2}</td> </tr> <tr> <td rowspan="3">Current</td> <td>0 to 20mA</td> <td rowspan="2">0 to 32000</td> <td>625.0nA</td> </tr> <tr> <td>4 to 20mA</td> <td>500.0nA</td> </tr> <tr> <td>User range setting (current)</td> <td>-32000 to 32000</td> <td>360.0nA^{*2}</td> </tr> </tbody> </table>	Analog output range		Digital value	Resolution	Voltage	0 to 5V	0 to 32000	156.3 μ V	1 to 5V	125.0 μ V	-10 to 10V	-32000 to 32000	312.5 μ V	User range setting (voltage)	312.5 μ V ^{*2}	Current	0 to 20mA	0 to 32000	625.0nA	4 to 20mA	500.0nA	User range setting (current)	-32000 to 32000	360.0nA ^{*2}
		Analog output range		Digital value	Resolution																					
		Voltage	0 to 5V	0 to 32000	156.3 μ V																					
			1 to 5V		125.0 μ V																					
			-10 to 10V	-32000 to 32000	312.5 μ V																					
			User range setting (voltage)		312.5 μ V ^{*2}																					
		Current	0 to 20mA	0 to 32000	625.0nA																					
4 to 20mA	500.0nA																									
User range setting (current)	-32000 to 32000		360.0nA ^{*2}																							
Accuracy (accuracy of the maximum analog output value) ^{*3}	Ambient temperature 25 \pm 5 $^{\circ}$ C	Within \pm 0.1% (voltage \pm 10mV, current \pm 20 μ A)																								
	Ambient temperature 0 to 55 $^{\circ}$ C	Within \pm 0.3% (voltage \pm 30mV, current \pm 60 μ A)																								
Operation mode (conversion speed)		High speed output mode (conversion speed: 1 μ s/CH) Normal output mode (conversion speed: 10 μ s/CH) Wave output mode (conversion speed: 20 μ s/CH)																								
Output response time ^{*4}		Voltage output: Maximum 20 μ s (-10 to 10V, 2k Ω load) Current output: Maximum 10 μ s (0 to 20mA, 250 Ω load)																								
Number of offset/gain settings ^{*5}		10000 times maximum																								
Output short circuit protection		Equipped																								
Isolation method		Between I/O terminals and programmable controller power supply: Photocoupler Between output channels: Non-isolation Between external power supply and analog output: Transformer isolation																								
Withstand voltage		Between I/O terminals and programmable controller power supply: 500VACrms for 1 minute Between external power supply and analog output: 500VACrms for 1 minute																								
Isolation resistance		Between I/O terminals and programmable controller power supply: 10M Ω or higher, at 500VDC																								
Number of occupied I/O points		16 points (I/O assignment: Intelligent 16 points)																								
External interface		18-point terminal block																								
Applicable wire size		0.3 to 0.75mm ² (22 to 18 AWG)																								
Applicable solderless terminal		R1.25-3 (solderless terminal with an insulation sleeve cannot be used)																								
External power supply		24VDC +20%, -15%																								
		Ripple, spike 500mV _{p-p} or lower																								
		Inrush current: 3.8A, 700 μ s or lower																								
		Current consumption: 0.13A																								
Internal current consumption (5VDC)		0.27A																								
External dimensions	Height	106mm (base unit mounting side: 98mm)																								
	Width	27.8mm																								
	Depth	131mm																								
Weight		0.20kg																								

*1 For details on the I/O conversion characteristics, refer to the following.

 Page 45 I/O Conversion Characteristics

*2 Maximum resolution in the user range setting.

*3 Except for the conditions under noise influence.

*4 The time required by the analog output signal from starting the output change to when the change is 90% complete.

*5 A count more than 10000 times causes Number of writes to offset/gain settings reach limit error (error code: 1080H).

3 FUNCTION LIST

The following shows the function list of the D/A converter module. For details on the functions, refer to the following.
 MELSEC iQ-R High Speed Digital-Analog Converter Module User's Manual (Application)

Item	Description
Range switching function	Allows switching the output range of an analog output for each channel. Switching the range makes it possible to change the I/O conversion characteristics.
D/A conversion enable/disable setting function	Controls whether to enable or disable the D/A conversion for each channel. Disabling the D/A conversion on unused channels reduces the D/A conversion cycles.
D/A output enable/disable setting function	Specifies whether to output the D/A conversion value or offset value for each channel. The conversion cycle is constant regardless of whether the output is enabled/disabled.
Analog output HOLD/CLEAR function	Controls whether to HOLD or CLEAR the analog output value output when the operation status of the CPU module is RUN, STOP, or stop error.
Analog output test function when the CPU module is in STOP status	Carries out the analog output test when the CPU module is in STOP status.
Scaling function	Performs scale conversion on digital values within a specified range between a scaling upper limit value and a scaling lower limit value. This function reduces the time and effort to create a program of the scale conversion.
Shift function	Adds the shift amount of the specified input value to the digital value.
Warning output function	Outputs a warning in the event the digital value exceeds the warning output upper limit or is lower than the warning output lower limit.
Rate control function	Prevents sudden changes in the analog output value by controlling the amount of increase or decrease of the analog output value per conversion cycle.
External power supply interruption detection function	Detects when the external power supply 24VDC is not supplied or the supply is stopped.
Disconnection detection function	Detects disconnections by monitoring the analog output value.
Interrupt function	Executes an interrupt program of the CPU module when an interrupt factor such as a disconnection or warning output is detected.
Wave output function	Registering prepared wave data (digital value) in the D/A converter module enables continuous analog output in the specified conversion cycle.
Inter-module synchronization function	Synchronizes the operation of multiple D/A converter modules and the D/A conversion timing of all channels.
Error history function	Records up to the 16 errors and alarms that occurred in the D/A converter module to store them into the buffer memory areas.
Event history function	Collects the errors and alarms that occurred and the operations executed in the D/A converter module as event information into the CPU module.
Offset/gain setting	Corrects errors in the D/A conversion value for each channel.
Backing up, saving, and restoring offset/gain values	Makes it possible to back up, save, and restore the offset/gain values of the user range.
Online module change	Allows module replacement without stopping the system. For the procedure of the online module change, refer to the following. MELSEC iQ-R Online Module Change Manual

Availability in each operation mode

The functions that can be used depend on the operation mode of the D/A converter module. The following table lists the availability of each function in each operation mode.

○: Available, ×: Not available

Item	Operation mode			
	High speed	Normal	Wave	Synchronization
Range switching function	○	○	○	○
D/A conversion enable/disable setting function	○	○	○	○
D/A output enable/disable setting function	○	○	○	○
Analog output HOLD/CLEAR function	○	○	○	○
Analog output test function when the CPU module is in STOP status	○	○	×	○
Scaling function	×	○	×	×
Shift function	×	○	×	×
Warning output function	×	○	○	○
Rate control function	×	○	×	×
External power supply interruption detection function	○	○	○	○
Disconnection detection function	×	○	○	○
Interrupt function	×	○	○	○
Wave output function	×	×	○	×
Inter-module synchronization function	×	×	×	○
Error history function	○	○	○	○
Event history function	○	○	○	○
Offset/gain setting	×	○	×	×
Backing up, saving, and restoring offset/gain values	×	○	×	×
Online module change	○	○	○	×

4 PROCEDURES BEFORE OPERATION

This chapter describes the procedures before operation.

1. Mounting a module

Mount the D/A converter module in any desired configuration.

2. Wiring

Perform wiring of external devices to the D/A converter module.

 Page 24 External Wiring

3. Adding a module

Add the D/A converter module to a module configuration by using the engineering tool. For details, refer to the following.

 GX Works3 Operating Manual

4. Parameter setting

Set the parameters of the D/A converter module by using the engineering tool. For details, refer to the following.

 MELSEC iQ-R High Speed Digital-Analog Converter Module User's Manual (Application)

5. Offset/gain setting

Perform the offset/gain setting to use a user range setting, if necessary.

6. Programming

Create a program. For details, refer to the following.

 Page 26 OPERATION EXAMPLES

MEMO

5 WIRING

This chapter describes the wiring of the D/A converter module.

5.1 Terminal Block

Precautions

Tighten the module fixing screws and others within the specified torque range.

Screw type	Tightening torque range
Module fixing screw (M3) ^{*1}	0.37 to 0.48N·m
Terminal screw (M3)	0.42 to 0.58N·m
Terminal block mounting screw (M3.5)	0.66 to 0.89N·m

*1 The hook on the top of the module allows the module to be fixed to a base unit easily. In a place where a vibration occurs frequently, however, fixing it with module fixing screws is recommended.

The following table lists an applicable solderless terminal to be connected to the terminal block. When wiring, use the applicable wire and tightening torque in the table. Use UL listed solderless terminals and, for processing, use the tools recommended by their manufacturer. Note that a solderless terminal with an insulation sleeve cannot be used.

Solderless terminal		Wire			
Model	Applicable tightening torque	Diameter	Type	Material	Temperature rating
R1.25-3	0.42 to 0.58N·m	0.3 to 0.75mm ² (22 to 18 AWG)	Stranded wire	Copper	75°C or higher

Signal names of the terminal block

The following table shows signal names of the terminal block.

Terminal block	Terminal number	Signal name
	1	CH1 V+
	2	CH1 COM
	3	CH1 I+
	4	NC
	5	CH2 V+
	6	CH2 COM
	7	CH2 I+
	8	NC
	9	CH3 V+
	10	CH3 COM
	11	CH3 I+
	12	NC
	13	CH4 V+
	14	CH4 COM
	15	CH4 I+
	16	+24V
	17	24G
	18	FG

Point

Terminal blocks that have been used on MELSEC-Q series digital-analog converter modules can be used just the way they are. The terminal layout is the same as the MELSEC-Q series high speed digital-analog converter modules (Q64DAH).

The terminal blocks for MELSEC-L series digital-analog converter modules, however, cannot be used because of the shape difference.

5.2 External Wiring

Wiring to the terminal block

The following figures show wiring to the terminal block.

- For the voltage output

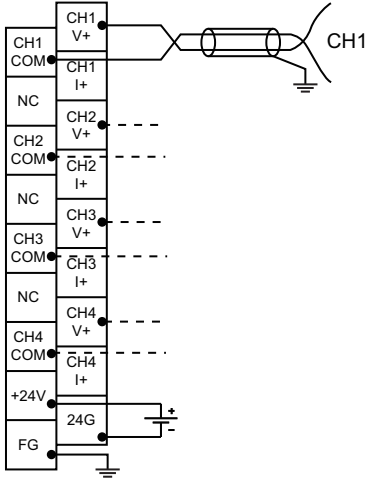

- For the current output

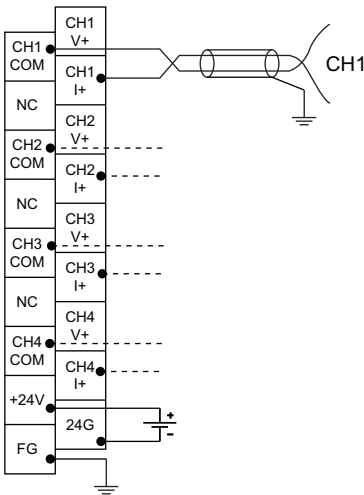

External wiring example

The following figure shows the example of external wiring.

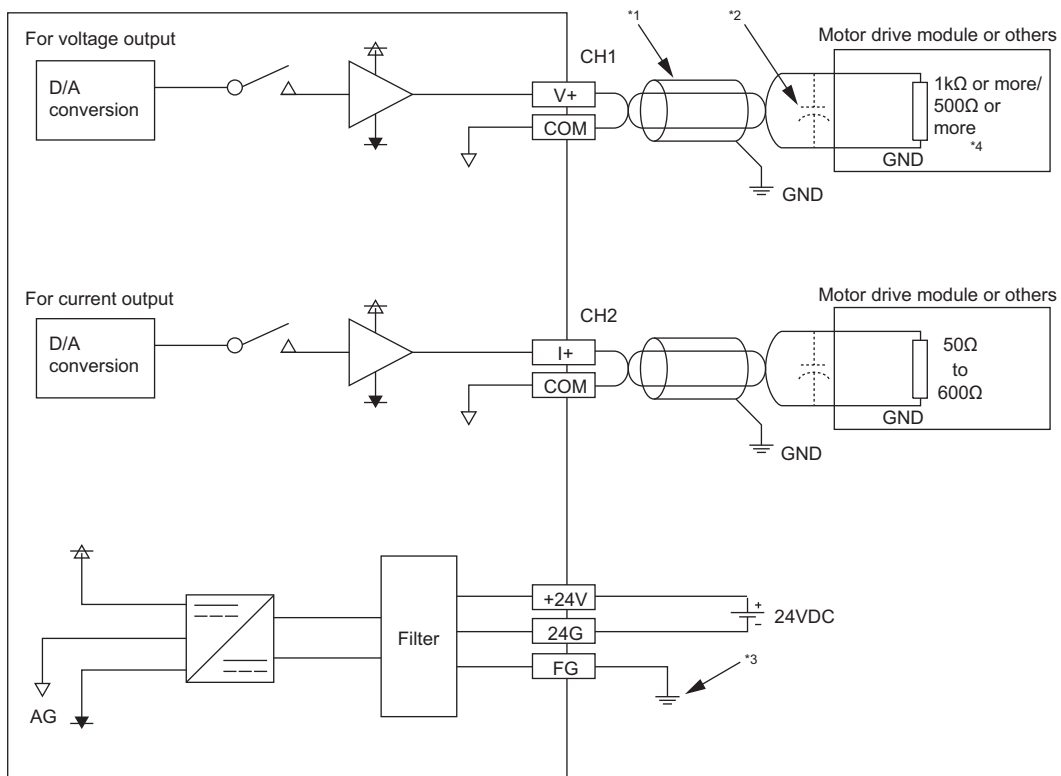

*1 For the wire, use the 2-core twisted cable.

*2 In the event a noise or ripple occurs in the analog signal, connect a capacitor of 0.1 to 0.47 μ F (withstand voltage of 25V or higher) to the input terminal of external devices.

*3 Be sure to ground the FG terminal.

*4 If used within the analog output range of 0 to 5V, specify the external load resistance value at 500 Ω or higher.
If used within the analog output range of -10 to 10V, specify the external load resistance value at 1k Ω or higher.



Ground the FG terminal of the power supply module.



6 OPERATION EXAMPLES

This chapter describes the programming procedure and the basic program of the D/A converter module.



6.1 Programming Procedure

Take the following steps to create a program for executing the D/A conversion. Programs for normal output mode and wave output mode are described.

For normal output mode

1. Set module parameters.
 Page 27 Module parameter
2. Create a program.
 Page 29 Program examples

For wave output mode

1. Set module parameters.
 Page 32 Module parameter
2. Configure the initial settings of the wave output function.
 Page 33 Initial settings of the wave output function
3. Create a program.
 Page 36 Program examples

Point

Using function blocks (FBs) reduces load at programming and improves the readability of programs. For details on the function blocks, refer to the following.

 MELSEC iQ-R Analog-Digital Converter Module/Digital-Analog Converter Module Function Block Reference

6.2 Program Example (for Normal Output Mode)

This section describes a program example when operating the D/A converter module in the normal output mode.

System configuration

The following figure is an example of the system configuration.

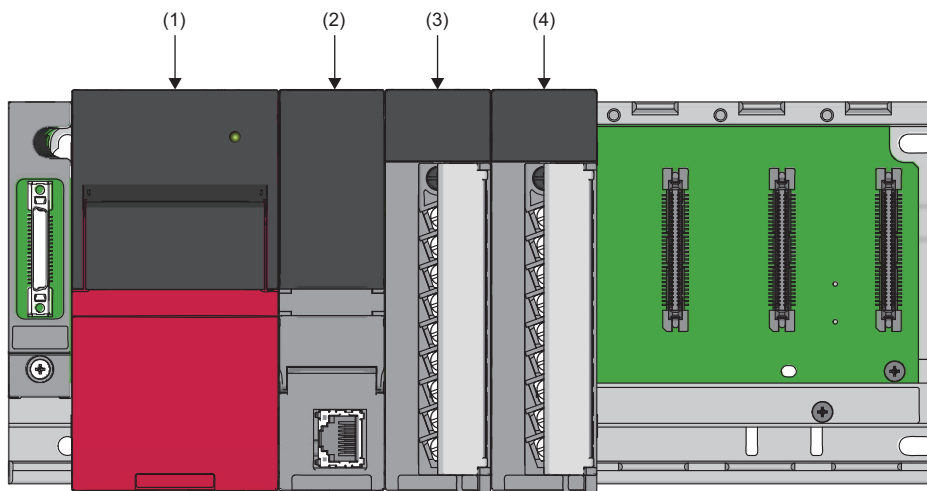

- (1) Power supply module (R61P)
- (2) CPU module (R04CPU)
- (3) D/A converter module (R60DAH4)
- (4) Input module (RX10)

Parameter settings

Perform initial settings in the module parameter of the engineering tool. The auto refresh setting does not need to be changed here. For details on the parameter settings, refer to the following.

📖 MELSEC iQ-R High Speed Digital-Analog Converter Module User's Manual (Application)

■Module parameter

Function	Setting item	CH1	CH2	CH3	CH4
Range switching function	Output range setting	-10 to 10V	-10 to 10V	0 to 20mA	4 to 20mA
Operation mode setting function	Operation mode setting	Normal output mode (10μs/CH)			
Output mode setting function	Analog output HOLD/CLEAR setting	HOLD	CLEAR	HOLD	HOLD
D/A conversion enable/disable setting function	D/A conversion enable/disable setting	D/A conversion enable	D/A conversion enable	D/A conversion enable	D/A conversion enable
Scaling function	Scaling enable/disable setting	Disable	Disable	Enable	Disable
	Scaling upper limit value	—	—	16000	—
	Scaling lower limit value	—	—	2000	—
Shift function	Input value shift amount	0	0	2000	0
Warning output function	Warning output setting	Disable	Enable	Disable	Disable
	Warning output upper limit value	—	32000	—	—
	Warning output lower limit value	—	0	—	—
Rate control function	Rate control enable/disable setting	Enable	Disable	Disable	Disable
	Increase digital limit value	8000	—	—	—
	Decrease digital limit value	1600	—	—	—

For parameters other than those mentioned above, set to the default value.

Label settings

GX Works3 provides functions that support the creation of a program.

The following table lists the module labels and global labels used for the program examples in this section.

There is no need to change the settings of the module labels. For details on the global labels, refer to the following.

 MELSEC iQ-R Programming Manual (Program Design)

Classification	Label name	Description	Device		
Module label	R60DAH_1.bModuleREADY	Module READY	X0		
	R60DAH_1.bExternalPowerSupplyREADY_Flag	External power supply READY flag	X7		
	R60DAH_1.bDisconnectionDetectionSignal	Disconnection detection signal	XD		
	R60DAH_1.bWarningOutputSignal	Warning output signal	XE		
	R60DAH_1.bErrorFlag	Error flag	XF		
	R60DAH_1.bCH1OutputEnableDisableFlag	CH1 Output enable/disable flag	Y1		
	R60DAH_1.bCH2OutputEnableDisableFlag	CH2 Output enable/disable flag	Y2		
	R60DAH_1.bCH3OutputEnableDisableFlag	CH3 Output enable/disable flag	Y3		
	R60DAH_1.bCH4OutputEnableDisableFlag	CH4 Output enable/disable flag	Y4		
	R60DAH_1.bWarningOutputClearRequest	Warning output clear request	YE		
	R60DAH_1.stnControl[0].wDigitalValue	CH1 Digital value	—		
	R60DAH_1.stnControl[1].wDigitalValue	CH2 Digital value	—		
	R60DAH_1.stnControl[2].wDigitalValue	CH3 Digital value	—		
	R60DAH_1.stnControl[3].wDigitalValue	CH4 Digital value	—		
	R60DAH_1.uDisconnectionDetectionFlag.3	CH4 Disconnection detection flag	—		
	R60DAH_1.uWarningOutputUpperFlag.1	CH2 Warning output upper flag	—		
	R60DAH_1.uWarningOutputLowerFlag.1	CH2 Warning output lower flag	—		
	Labels to be defined	Define global labels as shown below:			
		Label Name	Data Type	Class	Assign (Device/Label)
1		CH1_DigInVal	Word [Signed]	VAR_GLOBAL	D11
2		CH2_DigInVal	Word [Signed]	VAR_GLOBAL	D12
3		CH2_AlmUpLimit	Bit	VAR_GLOBAL	F0
4		CH2_AlmLowLimit	Bit	VAR_GLOBAL	F1
5		CH3_DigInVal	Word [Signed]	VAR_GLOBAL	D13
6		CH4_DigInVal	Word [Signed]	VAR_GLOBAL	D14
7		CH4_DisconnectDetect	Bit	VAR_GLOBAL	F2
8		DAOutputSig	Bit	VAR_GLOBAL	X11
9		ErrResetSig	Bit	VAR_GLOBAL	X13
10		ErrOperationENO	Bit	VAR_GLOBAL	
11		ErrOperationOK	Bit	VAR_GLOBAL	
12		ErrOperationEN	Bit	VAR_GLOBAL	
13		DigitWriteSig	Bit	VAR_GLOBAL	X10
14		UnitErrCode	Word [Signed]	VAR_GLOBAL	
15		UnitErrFlg	Bit	VAR_GLOBAL	
16		WarningOutClrSig	Bit	VAR_GLOBAL	X12

Program examples

Program example 1

This program is an example in which the digital values for D/A conversion of CH1 to 4 are set in the D/A converter module, then the analog output is enabled to start D/A conversion.

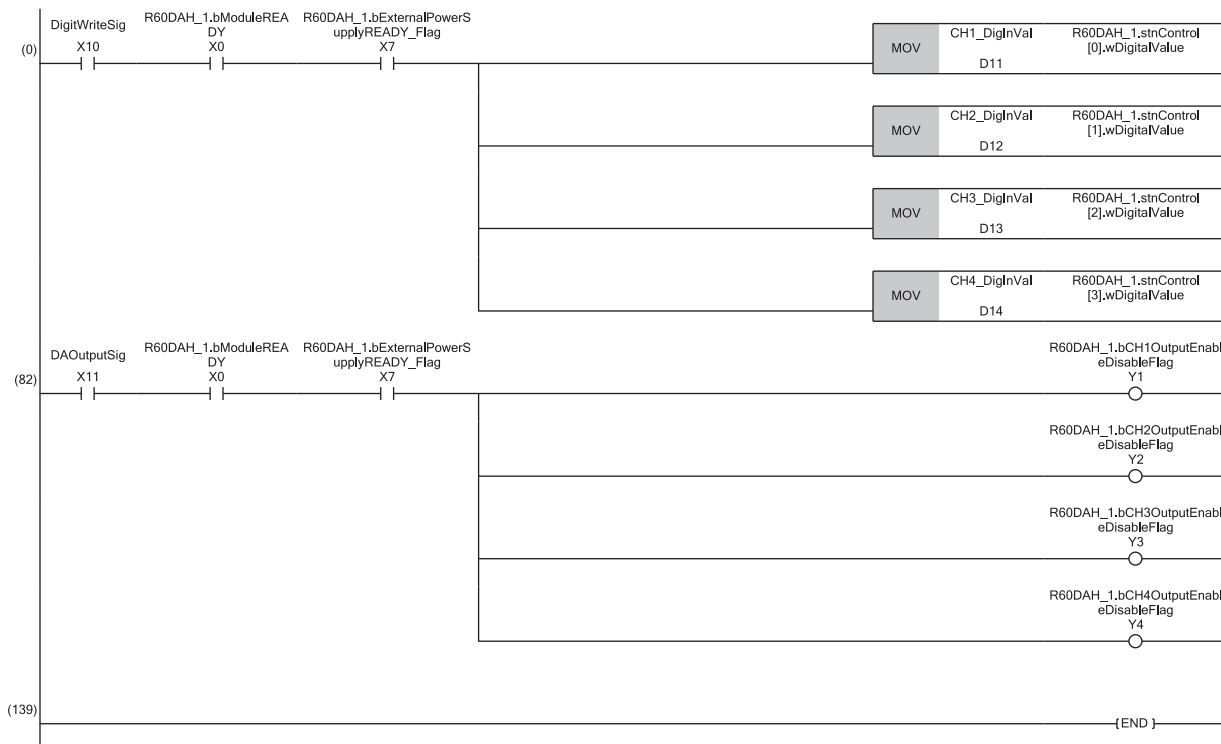

(0) Sets CH1 Digital value to CH4 Digital value.

(82) Enables the outputs of CH1 to 4.

Program example 2

This program is an example of carrying out the processing when a warning is output in CH2 of the D/A converter module and of clearing warning output.



(0) Carries out the processing when the CH2 upper limit warning occurs.

(30) Carries out the processing when the CH2 lower limit warning occurs.

(47) Turns on 'Warning output clear request' (YE).

(66) Turns off 'Warning output clear request' (YE).

Program example 3

This program is an example to display the latest error code when a disconnection is detected or an error is generated in CH4 of the D/A converter module. Subsequently, the program clears Disconnection detection flag, Error flag, and the stored error code.

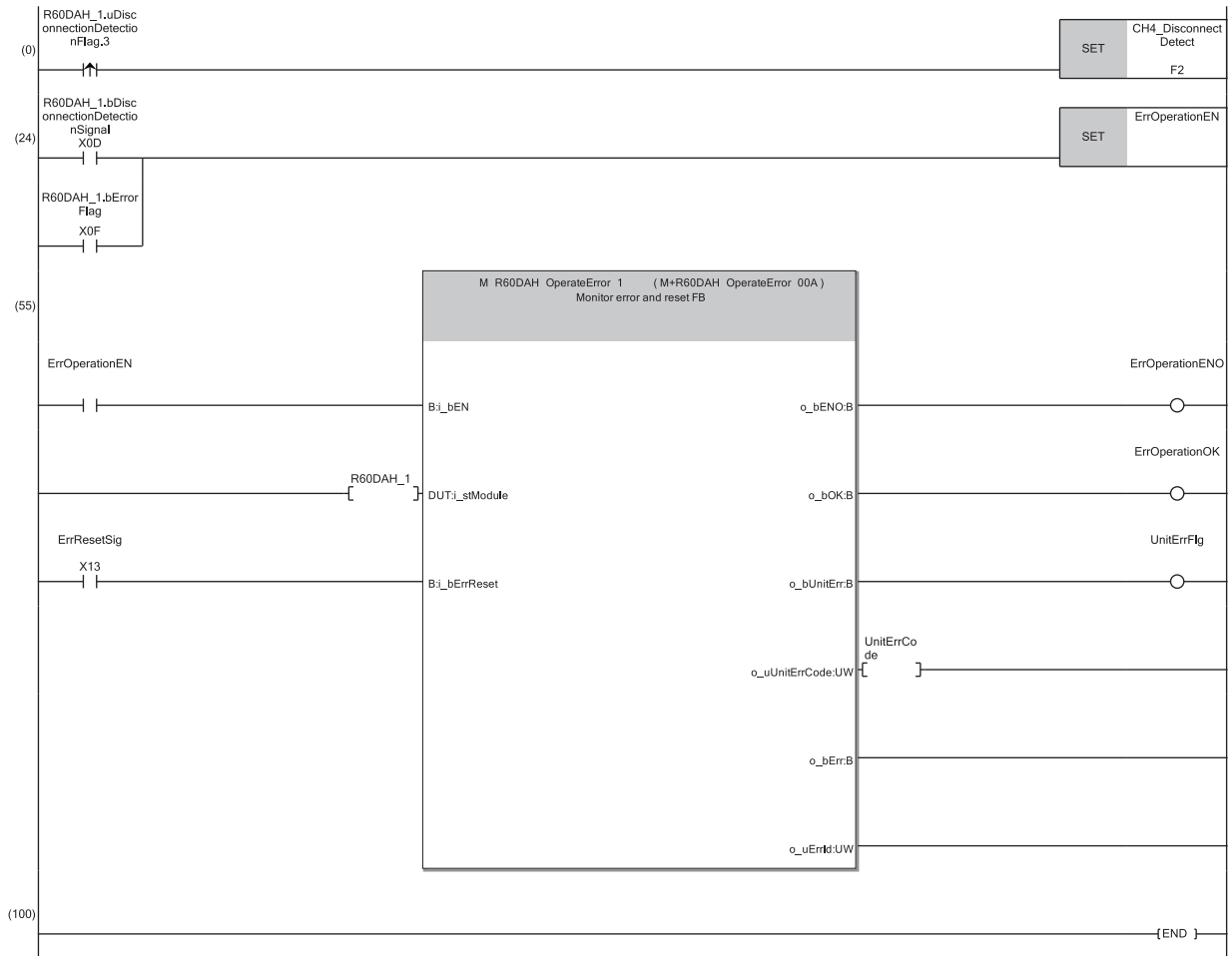

(0) Carries out the processing when a disconnection is detected.

(24) Turns on the error manipulation start flag.

6.3 Program Example (for Wave Output Mode)

This section describes the program examples when operating the D/A converter module in the wave output mode.

System configuration

The following figure is an example of the system configuration.

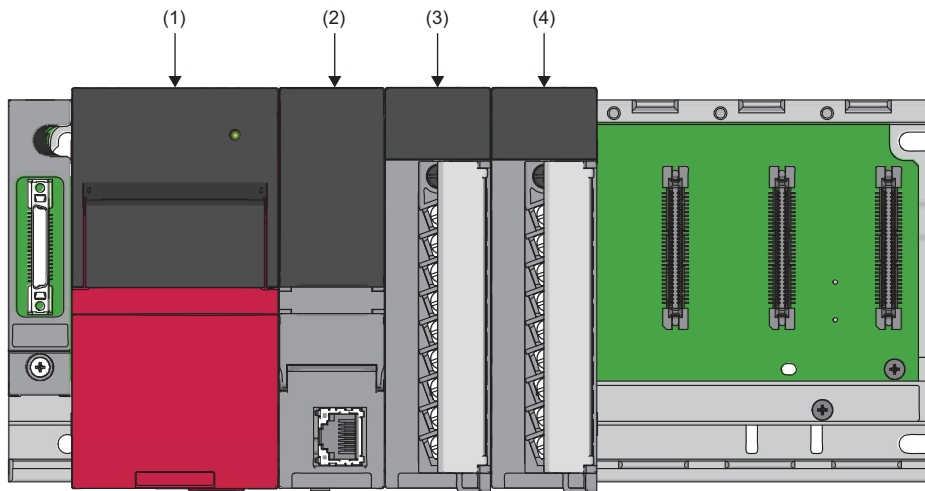

- (1) Power supply module (R61P)
- (2) CPU module (R120CPU)
- (3) D/A converter module (R60DAH4)
- (4) Input module (RX10)

Programming conditions

- Output the voltage delineating the sine wave locus from CH1.
- Store the wave pattern and parameter settings of the wave output function in the file register of the CPU module.

Program configuration

The program for the wave output mode has the following configuration. Execute the program in the order described below.

1. Wave output data read processing program

☞ Page 36 Wave output data read processing program example

2. Operating condition setting request processing program

☞ Page 38 Operating condition setting request processing program example

3. Wave output start processing program

☞ Page 39 Wave output start processing program example

Moreover, if the parameters of the wave output function need to be changed upon execution of the wave output data read processing program, execute the following program.

☞ Page 37 Wave output parameter setting processing program example

Parameter settings

Perform the initial settings in the module parameters and wave output data creation of the engineering tool. The auto refresh setting does not need to be changed here.

■Module parameter

Set the module parameters as follows.

Function	Setting item	CH1	CH2	CH3	CH4
Range switching function	Output range setting	-10 to 10V	4 to 20mA	4 to 20mA	4 to 20mA
Operation mode setting function	Operation mode setting	Wave output mode (20µs/CH)			
Output mode setting function	Analog output HOLD/CLEAR setting	HOLD	CLEAR	CLEAR	CLEAR
D/A conversion enable/disable setting function	D/A conversion enable/disable setting	D/A conversion disable	D/A conversion disable	D/A conversion disable	D/A conversion disable
Scaling function	Scaling enable/disable setting	Disable	Disable	Disable	Disable
	Scaling upper limit value	—	—	—	—
	Scaling lower limit value	—	—	—	—
Shift function	Input value shift amount	0	0	0	0
Warning output function	Warning output setting	Enable	Disable	Disable	Disable
	Warning output upper limit value	32000	—	—	—
	Warning output lower limit value	0	—	—	—
Rate control function	Rate control enable/disable setting	Disable	Disable	Disable	Disable
	Increase digital limit value	—	—	—	—
	Decrease digital limit value	—	—	—	—

For details on the module parameters, refer to the following.

 MELSEC iQ-R High Speed Digital-Analog Converter Module User's Manual (Application)

Initial settings of the wave output function

Create the wave pattern and parameters of wave output function in the wave output data creation tool. For details on the creation method, refer to the following.

📖 MELSEC iQ-R High Speed Digital-Analog Converter Module User's Manual (Application)

1. Configure the file register settings of the CPU parameter as follows to enable usage of the file register.

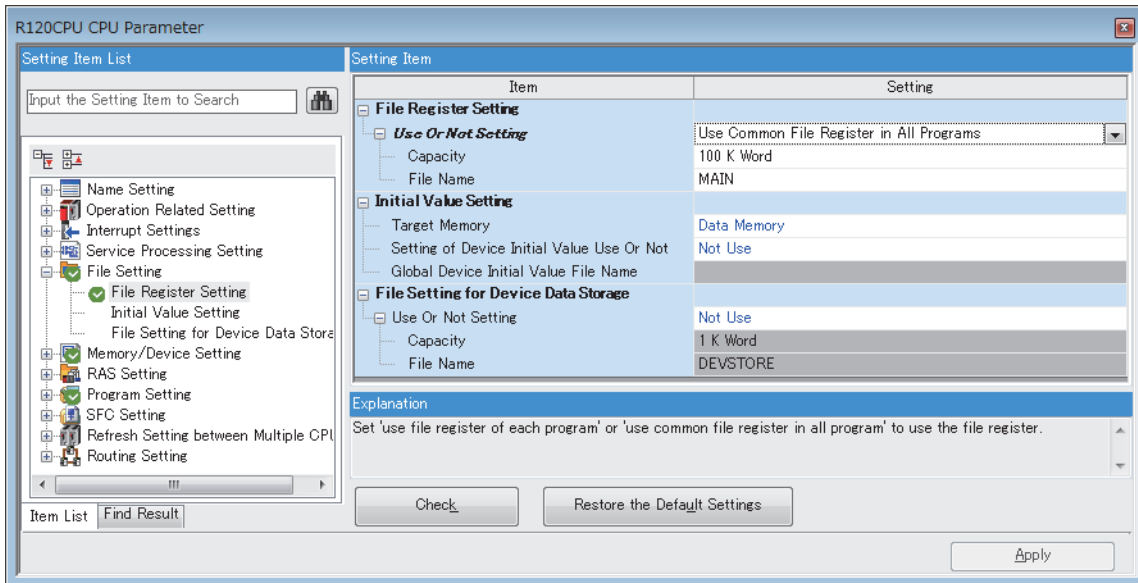

2. Launch "Create Wave Output Data".

🖱️ [Tool] ⇒ [Module Tool List] ⇒ [Analog Output] ⇒ [Create wave output data]

3. Display the "Register wave pattern" window, and set as follows.

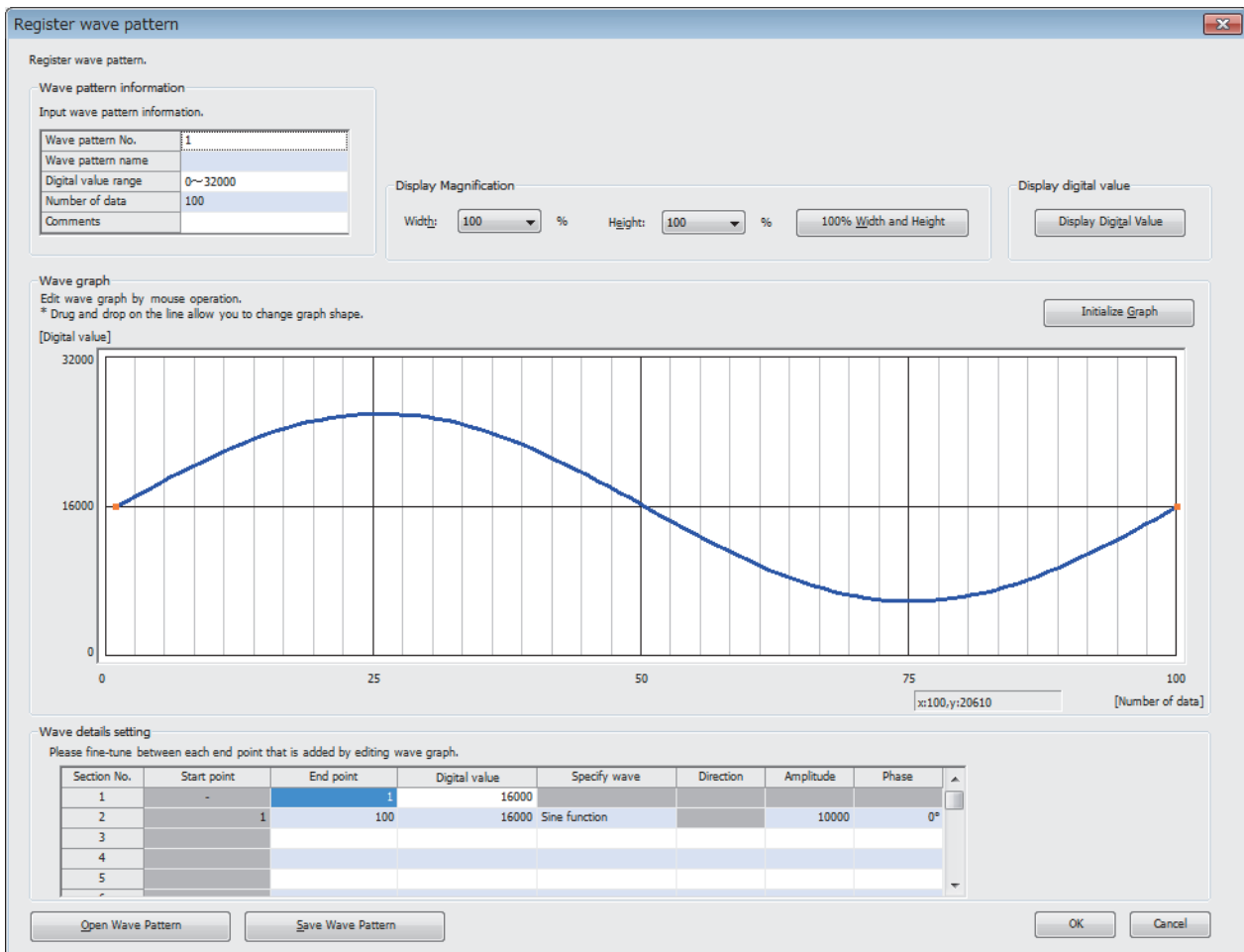

4. In "Wave output data setting", set as follows.

Create Wave Output Data

Module Type: R60DAH4

Register wave pattern

Register wave pattern for creating wave output data. * Select graph part and press 'Enter' to open registration window.

Wave pattern No.	1	2	3	4
Graph				
Wave pattern name	-	-	-	-
Digital value range	0~32000	-	-	-
Number of data	100	-	-	-
Comments	-	-	-	-

Wave output data setting

Input wave output data.

	CH1	CH2	CH3	CH4
Wave pattern No.	1	-	-	-
Output setting during wave output stop	0:0V/mA	0:0V/mA	0:0V/mA	0:0V/mA
Output value during wave output stop	0	0	0	0
Wave pattern start address setting	10000	10000	10000	10000
Wave pattern data points setting	100	0	0	0
Wave pattern output repetition setting	10000	1	1	1
Constant for wave output conversion cyc	1000	1	1	1

Specify 'Wave pattern No.' for wave outputting.
Pattern specification is limited up to 3.
1 to 10

Number of data: 100
Empty point: 89900

Open/Save wave output data file

Read and save all the information that has been created for wave output data.

Open Wave Output Data from File Save Wave Output Data to File

Write Wave Output Data

Write wave output data to use in modules to project device memory or the specified place.
(* After the operation, it is necessary to write the output data to PLC.)

Read Wave Output Data

Read wave output data to use in modules from project device memory or the specified place.
(* Read from PLC operation is required in advance.)

Write to Device Memory Write Data for Memory Card Read from Device Memory Read Data for Memory Card

Close

5. Click the [Write to Device Memory] button, and write the wave output data in the device memory.

Label settings

GX Works3 provides functions that support the creation of a program.

The following table lists the module labels and global labels used for the program examples in this section.

There is no need to change the settings of the module labels. For details on the global labels, refer to the following.

 MELSEC iQ-R Programming Manual (Program Design)

Classification	Label name	Description	Device		
Module label	R60DAH_1.bModuleREADY	Module READY	X0		
	R60DAH_1.bExternalPowerSupplyREADY_Flag	External power supply READY flag	X7		
	R60DAH_1.bOperatingConditionSettingCompletedFlag	Operating condition setting completed flag	X9		
	R60DAH_1.bCH1OutputEnableDisableFlag	CH1 Output enable/disable flag	Y1		
	R60DAH_1.bOperatingConditionSettingRequest	Operating condition setting request	Y9		
	R60DAH_1.stnControl_D[0].uWaveOutputStartStopRequest_D	CH1 Wave output start/stop request	U0\G462		
	R60DAH_1.stnSetting_D[0].uD_A_conversionEnableDisableSetting_D	CH1 D/A conversion enable/disable setting	U0\G500		
Labels to be defined	Define global labels as shown below:				
		Label Name	Data Type	Class	Assign (Device/Label)
	1	WaveDataStoreDevErrorCode	Word [Signed]	VAR_GLOBAL	D0
	2	WaveOutputSettingOutputSelect	Word [Signed]	VAR_GLOBAL	D10
	3	WaveOutputSettingOutputValue	Word [Signed]	VAR_GLOBAL	D11
	4	WaveOutputSettingStartingAddr	Double Word [Unsigned]/Bit String [32-bit]	VAR_GLOBAL	D12
	5	WaveOutputSettingPointsSetting	Double Word [Signed]	VAR_GLOBAL	D14
	6	WaveOutputSettingFrequency	Word [Signed]	VAR_GLOBAL	D16
	7	WaveOutputSettingConvSpeed	Word [Signed]	VAR_GLOBAL	D17
	8	WaveOutputSettingErrorCode	Word [Signed]	VAR_GLOBAL	D18
	9	RequestSettingErrorCode	Word [Signed]	VAR_GLOBAL	D20
	10	WaveStartStop	Word [Signed]	VAR_GLOBAL	D30
	11	WaveStatusCH1	Word [Signed]	VAR_GLOBAL	D31
	12	WaveStatusCH2	Word [Signed]	VAR_GLOBAL	D32
	13	WaveStatusCH3	Word [Signed]	VAR_GLOBAL	D33
	14	WaveStatusCH4	Word [Signed]	VAR_GLOBAL	D34
	15	WaveOutputReqSettingErrorCode	Word [Signed]	VAR_GLOBAL	D39
	16	WaveDataStoreDevERR	Bit	VAR_GLOBAL	F0
	17	WaveOutputSettingERR	Bit	VAR_GLOBAL	F10
	18	RequestSettingERR	Bit	VAR_GLOBAL	F20
	19	WaveOutputReqSettingERR	Bit	VAR_GLOBAL	F30
	20	WaveDataStoreDevEN	Bit	VAR_GLOBAL	M0
	21	WaveDataStoreDevENO	Bit	VAR_GLOBAL	M1
	22	WaveDataStoreDevOK	Bit	VAR_GLOBAL	M2
	23	WaveOutputSettingEN	Bit	VAR_GLOBAL	M10
	24	WaveOutputSettingENO	Bit	VAR_GLOBAL	M11
	25	WaveOutputSettingOK	Bit	VAR_GLOBAL	M12
	26	RequestSettingEN	Bit	VAR_GLOBAL	M20
	27	RequestSettingENO	Bit	VAR_GLOBAL	M21
	28	RequestSettingOK	Bit	VAR_GLOBAL	M22
	29	WaveOutputReqSettingEN	Bit	VAR_GLOBAL	M30
	30	WaveOutputReqSettingENO	Bit	VAR_GLOBAL	M31
	31	WaveOutputReqSettingOK	Bit	VAR_GLOBAL	M32
	32	WaveDataStoreReq	Bit	VAR_GLOBAL	X14
	33	WaveOutputSetting	Bit	VAR_GLOBAL	X15
	34	WaveRequestSetting	Bit	VAR_GLOBAL	X16
	35	OutputReq	Bit	VAR_GLOBAL	X17
36	WaveStartStopReq	Bit	VAR_GLOBAL	X18	

Program examples

Wave output data read processing program example

Set CH1 D/A conversion enable/disable setting to D/A conversion enable. Moreover, read the data from the file register (ZR) in which the wave pattern and parameter settings of wave output function are stored and register it in the buffer memory of the D/A converter module.

Once the wave output data read is completed, enable the settings using the operating condition setting request program.

(Page 38 Operating condition setting request processing program example)

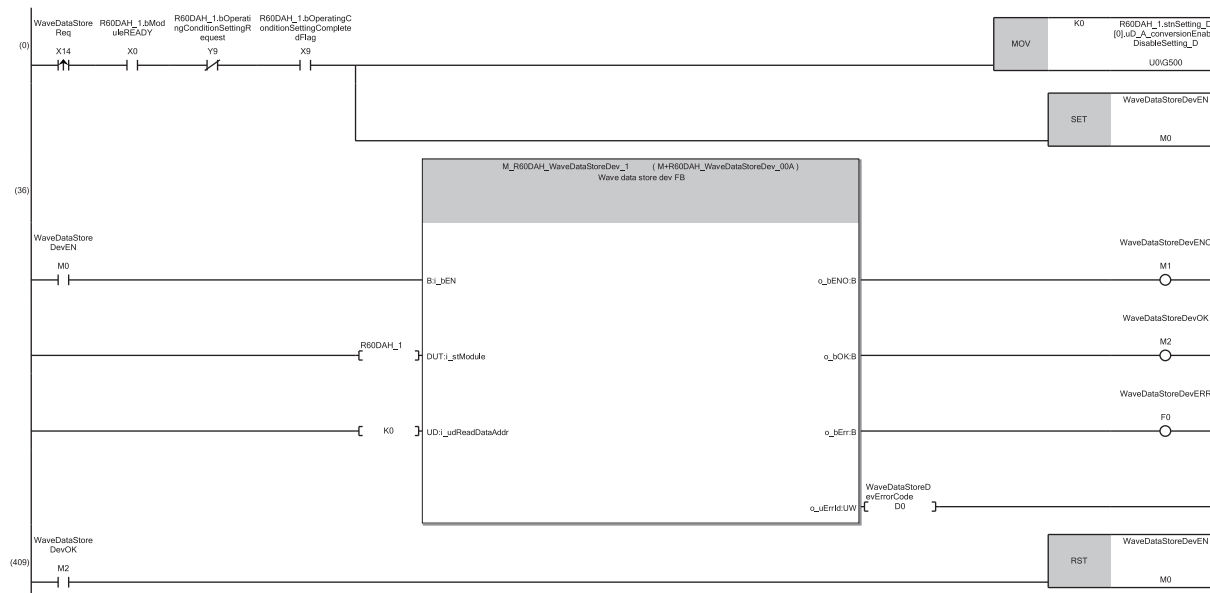

(0) Sets 'CH1 D/A conversion enable/disable setting' (U0\G500) to D/A conversion enable (0).

(36) Turns on the wave data read (device) function block start flag (M0) and registers the wave pattern and parameter settings of wave output function in the buffer memory.

(409) Turns off the wave data read (device) function block start flag (M0).

Wave output parameter setting processing program example

This example shows the program to be used when part of the parameter settings of the wave output function read from the file register (ZR) and CSV file need to be changed. If there is no need to change the settings, this program is not required. After the change, enable the settings using the operating condition setting request program. (Page 38 Operating condition setting request processing program example)

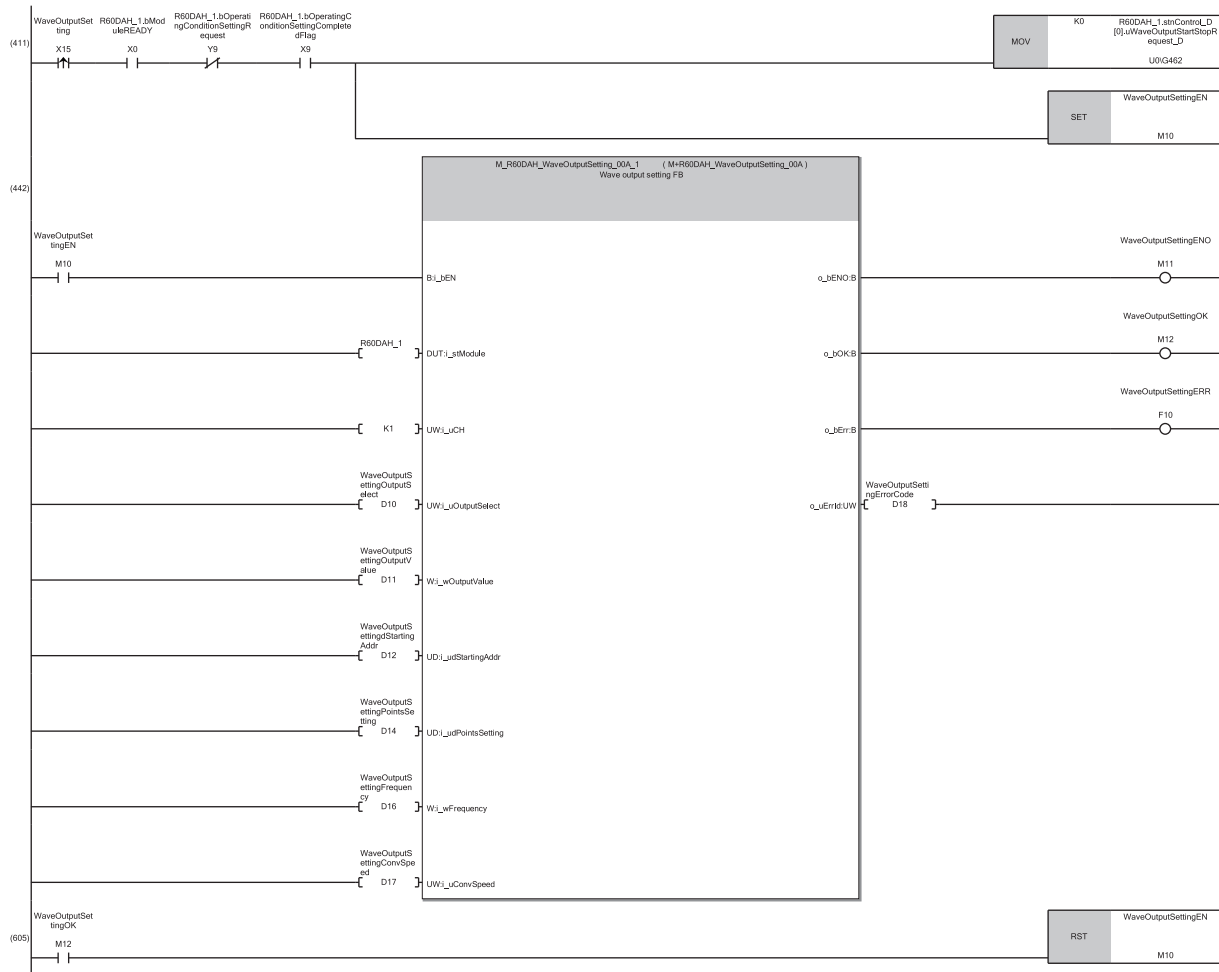

(411) Sets 'CH1 Wave output start/stop request' (U0/G462) to Wave output stop request (0).

(442) Turns on the wave output setting function block start flag (M10) and changes the value of the buffer memory of the wave output function.

(605) Turns off the wave output setting function block start flag (M10).

Operating condition setting request processing program example

When newly registering wave output parameters or changing the setting values, enable the settings using this program.

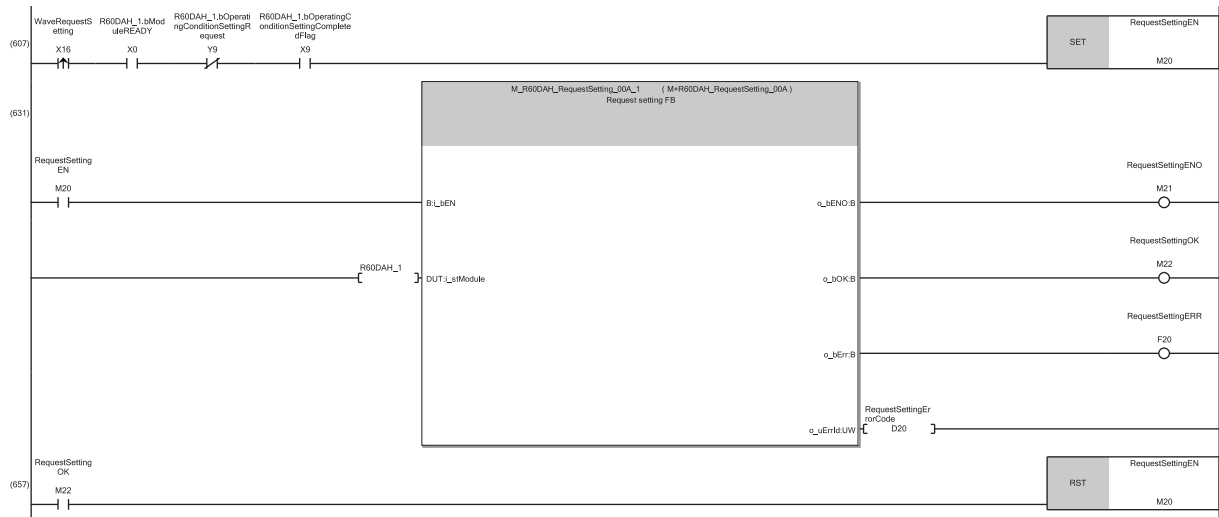

(607) Turns on the operating condition setting request function block start flag (M20).

(631) Carries out operating condition setting request processing.

(657) Turns off the operating condition setting request function block start flag (M20).

Wave output start processing program example

This example shows a program for starting the CH1 wave output.

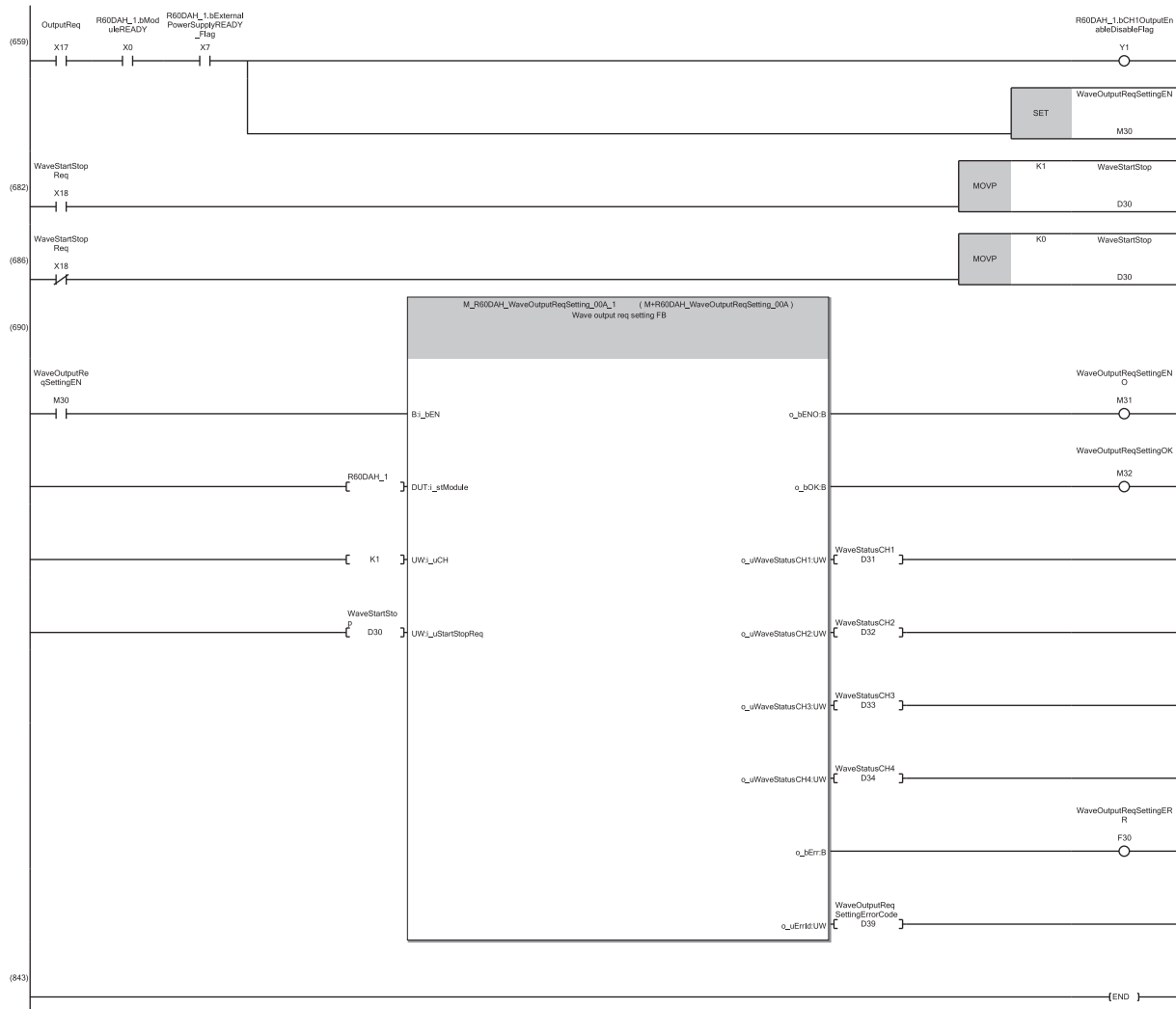

(659) Turns on 'CH1 Output enable/disable flag' (Y1).

(682) Turns on the wave data output start/stop request (X18) and sets the wave output start/stop request (D30) to the wave output start request (1).

(686) When stopping the wave output, turns off the wave data output start/stop request (X18) and sets the wave output start/stop request (D30) to the wave output stop request (0).

(690) Turns on the wave output start/stop request function block start flag (M30), then starts or stops the wave output.

7 OFFSET/GAIN SETTING

Using the user range setting requires setting the offset and gain values.

Access the "Offset/Gain Setting" window in the engineering tool to set the offset and gain values.

Setting procedure

The procedure for the offset/gain setting of the D/A converter module is as follows. The offset/gain setting is disabled in the high-speed output mode, the wave output mode, and the inter-module synchronization mode. Change the mode to the normal output mode or the offset/gain setting mode and set the offset and gain values.

In addition, do not turn off the external power supply while in the offset/gain setting. If the external power supply is turned off while in the offset/gain setting, the offset/gain setting cannot be properly completed.

1. In "Analog Output", select "Offset/gain setting (High-Speed Analog)" and click the [OK] button.

 [Tool] ⇒ [Module Tool List]

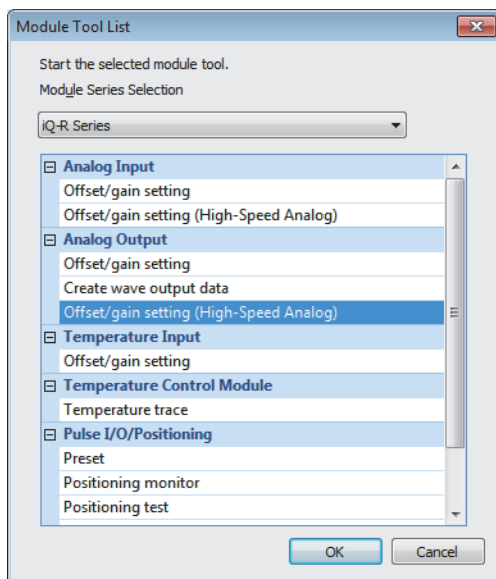

2. Select the target module for the offset/gain setting, and click the [OK] button.

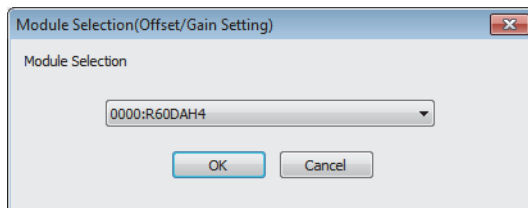

3. Click the [Yes] button.

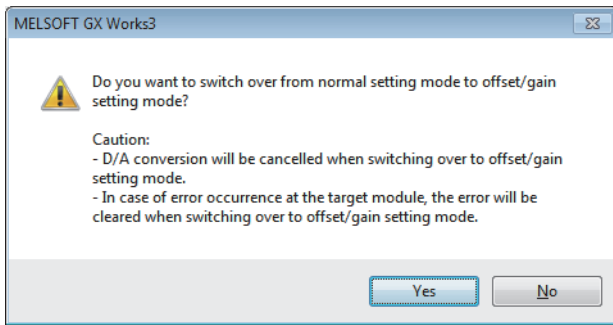

4. Specify the channel where offset and gain values are to be set and specify the user range setting.

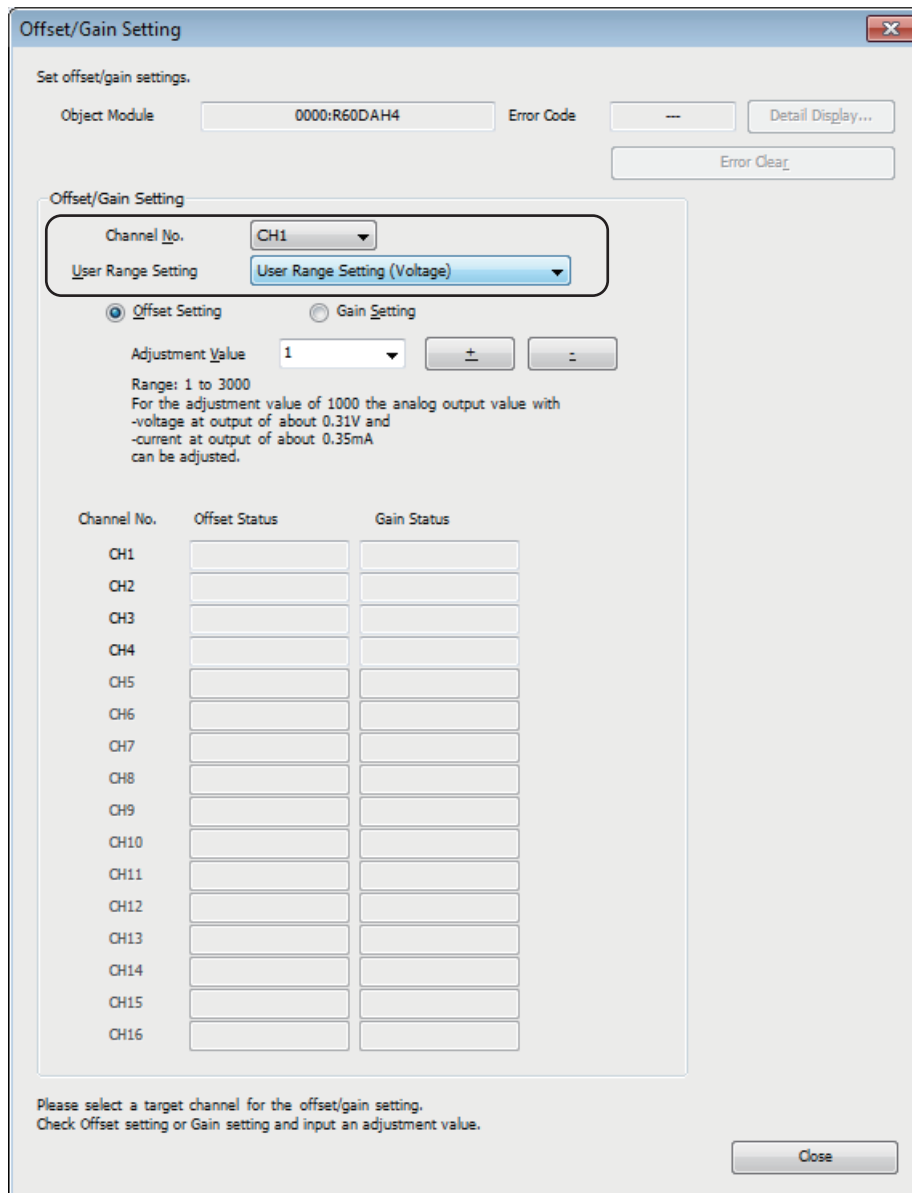

- Specify whether to configure the offset setting or gain setting with the radio button. (The steps from step 6 assume that the offset setting has been specified.)

Offset/Gain Setting

Set offset/gain settings.

Object Module: 0000:R60DAH4 Error Code: --- Detail Display...

Error Clear

Offset/Gain Setting

Channel No.: CH1

User Range Setting: User Range Setting (Voltage)

Offset Setting Gain Setting

Adjustment Value: 1 ± -

Range: 1 to 3000
 For the adjustment value of 1000 the analog output value with
 -voltage at output of about 0.31V and
 -current at output of about 0.35mA
 can be adjusted.

Channel No.	Offset Status	Gain Status
CH1		
CH2		
CH3		
CH4		
CH5		
CH6		
CH7		
CH8		
CH9		
CH10		
CH11		
CH12		
CH13		
CH14		
CH15		
CH16		

Please select a target channel for the offset/gain setting.
 Check Offset setting or Gain setting and input an adjustment value.

Close

6. The adjustment amount of the offset value or gain value has to be selected from "1", "100", "500", "1000", "2000", and "3000" first; however, further fine adjustments are also possible by entering a desired value (1 to 3000).

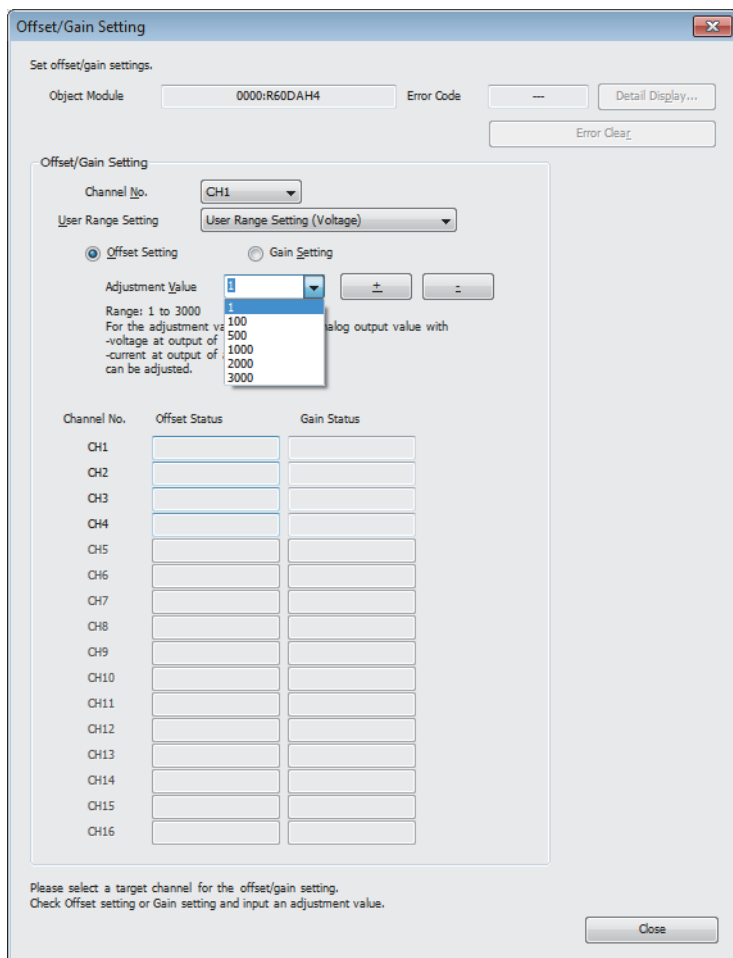

7. Click the [+ (+)] button or [- (-)] button to make fine adjustments to the selected adjustment value to obtain the analog output voltage value or analog output current value.
8. The "Offset Status" of the specified channel is changed to "Changed".

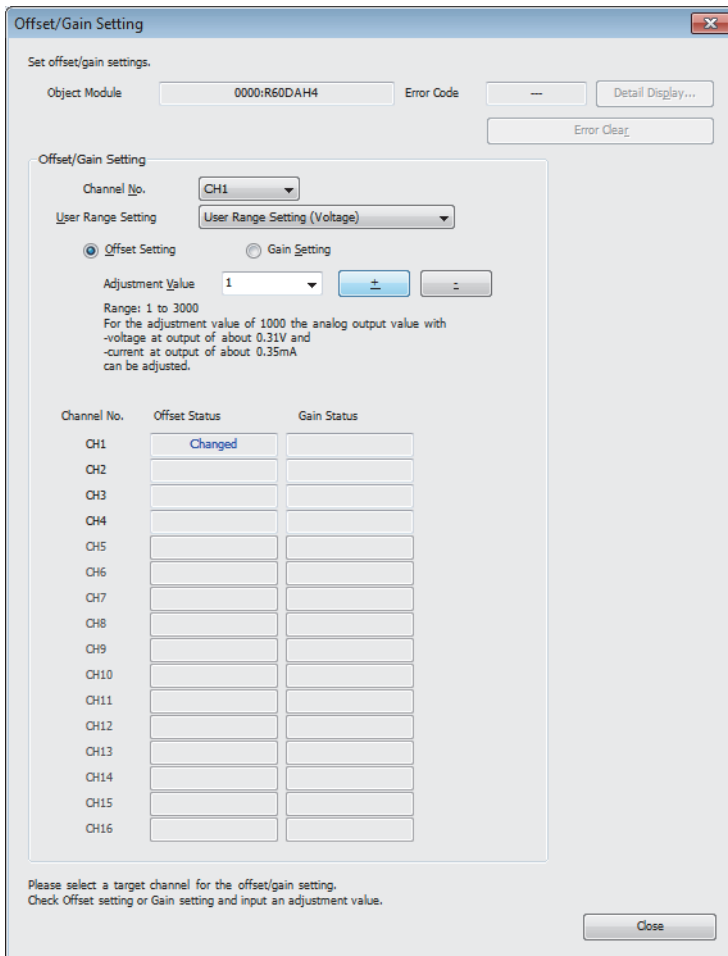

9. To configure the gain setting, repeat the steps from step 5.
10. After the setting is completed, click the [Close] button.
11. Click the [Yes] button.

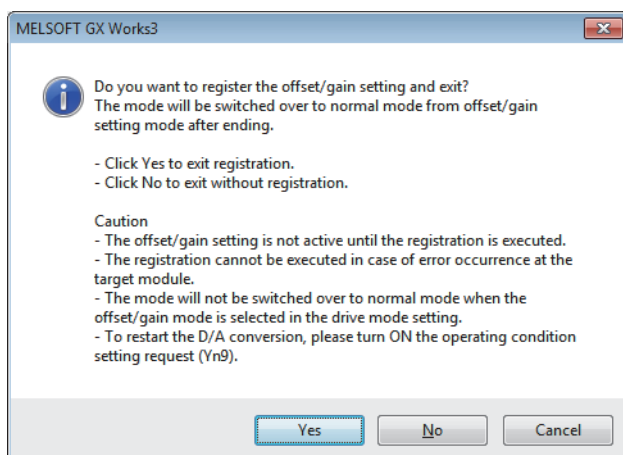

APPENDICES

Appendix 1 I/O Conversion Characteristics

An I/O conversion characteristic of D/A conversion is expressed by the slope of the straight line connecting the offset value and the gain value at the time when a digital value written from the CPU module is converted to an analog output value (voltage or current).

Offset value

This is the analog output value (voltage or current) when the digital value set from the CPU module is 0.

Gain value

This is the analog output value (voltage or current) when the digital value set from the CPU module is 32000.

Voltage output characteristic

The following shows the list of the analog output ranges and the graph of each voltage output characteristic, at the voltage output.

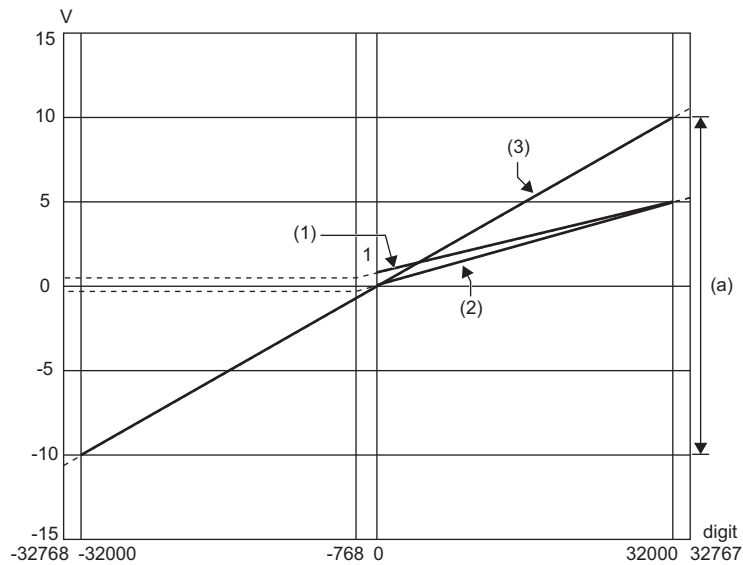

digit: Digital value

V: Analog output voltage (V)

(a): Practical analog output range

No.	Analog output range setting	Offset value	Gain value	Digital value	Resolution
(1)	1 to 5V	1V	5V	0 to 32000	125.0 μ V
(2)	0 to 5V	0V	5V		156.3 μ V
(3)	-10 to 10V	0V	10V	-32000 to 32000	312.5 μ V
—	User range setting	*1	*1	-32000 to 32000	312.5 μ V ^{*2}

*1 Set the offset value and gain value in the user range setting within a range that satisfies the following conditions. If the following conditions are not satisfied, D/A conversion may not be performed properly.

·Setting range of the offset value and gain value: -10 to 10V

·((gain value) - (offset value)) \geq 4V

*2 Maximum resolution in the user range setting.

Point

Set values within the practical range of the digital input and analog output at each output range. If the values are out of the range, the resolution and accuracy may not fall within the range of the performance specifications. (Do not use values in the dotted line regions in the graph of voltage output characteristics.)

Current output characteristic

The following shows the list of the analog output ranges and the graph of each current output characteristic, at the current output.

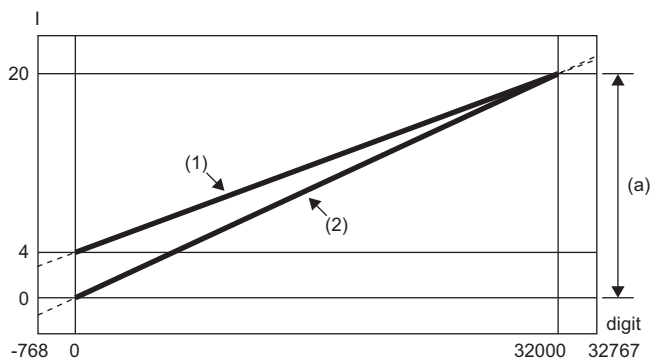

digit: Digital value

I: Analog output current (mA)

(a): Practical analog output range

No.	Analog output range setting	Offset value	Gain value	Digital value	Resolution
(1)	4 to 20mA	4mA	20mA	0 to 32000	500.0nA
(2)	0 to 20mA	0mA	20mA		625.0nA
—	User range setting	*1	*1	-32000 to 32000	360.0nA*2

*1 Set the offset value and gain value in the user range setting within a range that satisfies the following conditions. If the following conditions are not satisfied, D/A conversion may not be performed properly.

·Offset value ≥ 0 mA, gain value ≤ 20 mA

·((gain value) - (offset value)) ≥ 11.6 mA

*2 Maximum resolution in the user range setting.

Point

Set values within the practical range of the digital input and analog output at each output range. If the values are out of the range, the resolution and accuracy may not fall within the range of the performance specifications. (Do not use values in the dotted line regions in the graph of current output characteristics.)

A

Appendix 2 Accuracy

Accuracy of D/A conversion is determined by the accuracy of the maximum value of analog output value.

An output characteristic change through changes of the offset/gain setting or the output range does not sacrifice the accuracy, which is maintained within the described range of the performance specifications.

The following graph shows the fluctuation range of accuracy when the range of -10 to 10V is selected.

The accuracy is $\pm 0.1\%$ ($\pm 10\text{mV}$) at ambient temperature of $25\pm 5^\circ\text{C}$; the accuracy is $\pm 0.3\%$ ($\pm 30\text{mV}$) at ambient temperature of 0 to 55°C (except for the conditions under noise influence).

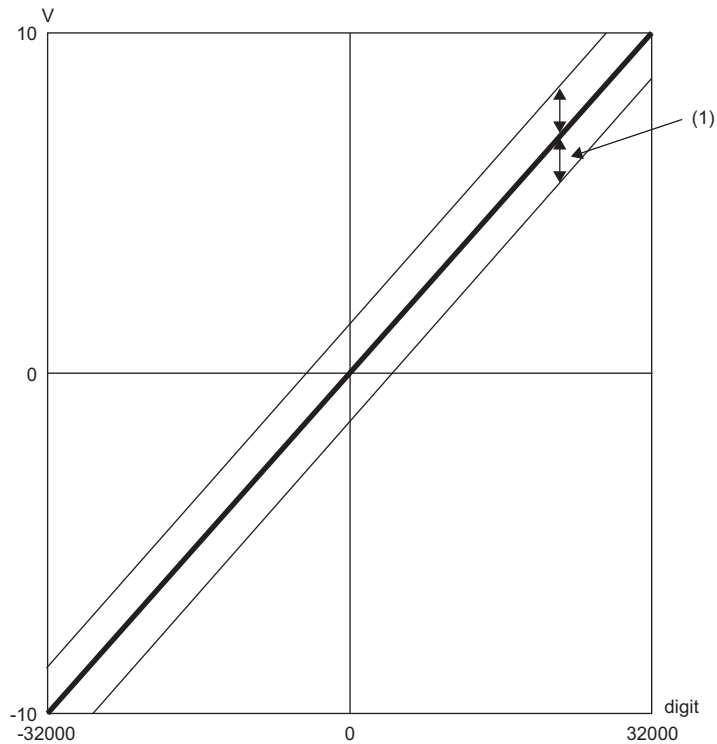

digit: Digital value

V: Analog output voltage (V)

(1): Fluctuation range

Appendix 3 Output Response Time

The output response time is the time required by the analog output signal from starting the output change to when the change is 90% complete. The time is extended or reduced depending on the variation of analog output. Note that the output response time becomes longer (voltage output: 20 μ s, current output: 10 μ s) in the system with sudden output changes. In addition, the output response time may be extended depending on the length of the cable used due to impedance of the cable.

The following figure shows the output response time of when the analog output is changed from the lower limit value (-10V) to the upper limit value (10V) of the output range.

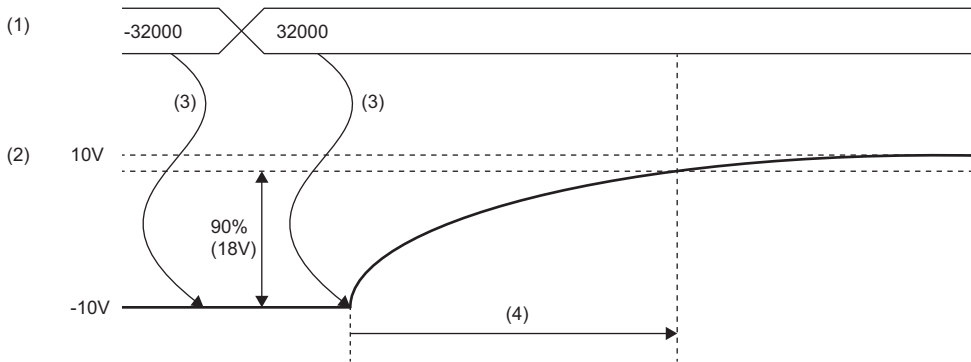

- (1): Digital value
- (2): Analog output range (-10 to 10V)
- (3): D/A conversion timing
- (4): Output response time (maximum 20 μ s)

Appendix 4 External Dimensions

The following figure shows the external dimensions of the D/A converter module.

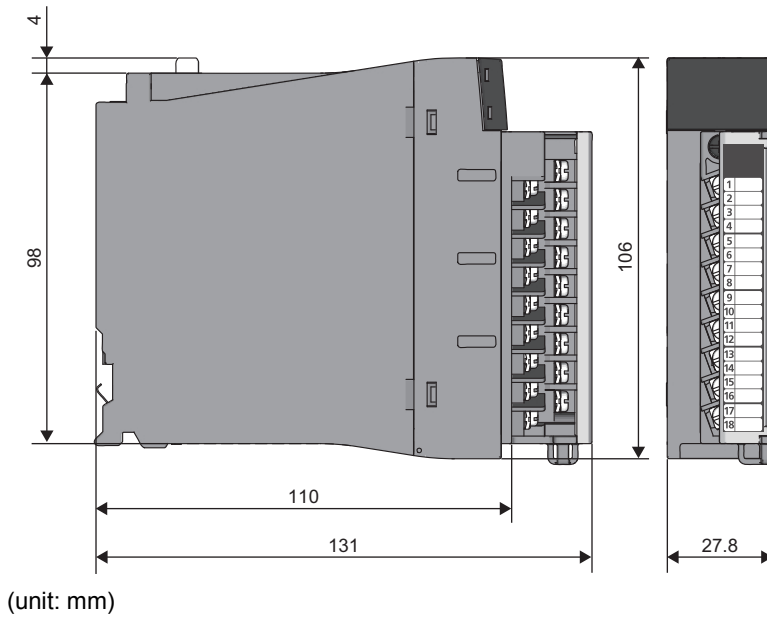

MEMO

A

INDEX

A

Accuracy of D/A conversion	48
ALM LED	15

C

Current output characteristic	47
---	----

E

ERR LED	15
External dimensions	50
External wiring	24
External wiring example.	25

F

Function block (FB).	26
------------------------------	----

G

Gain value	45
----------------------	----

O

Offset value	45
Offset/gain setting	40
Output response time	49

P

Performance specifications	17
Production information marking	15
Program example (for normal output mode).	27
Program example (for wave output mode).	31

R

RUN LED.	15
------------------	----

S

Signal names of the terminal block	23
--	----

T

Terminal block	15,23
--------------------------	-------

V

Voltage output characteristic	46
---	----

MEMO

REVISIONS

*The manual number is given on the bottom left of the back cover.

Revision date	*Manual number	Description
February 2017	SH(NA)-081655ENG-A	First edition

Japanese manual number: SH-081654-A

This manual confers no industrial property rights of any other kind, nor does it confer any patent licenses. Mitsubishi Electric Corporation cannot be held responsible for any problems involving industrial property rights which may occur as a result of using the contents noted in this manual.

© 2017 MITSUBISHI ELECTRIC CORPORATION

WARRANTY

Please confirm the following product warranty details before using this product.

1. Gratis Warranty Term and Gratis Warranty Range

If any faults or defects (hereinafter "Failure") found to be the responsibility of Mitsubishi occurs during use of the product within the gratis warranty term, the product shall be repaired at no cost via the sales representative or Mitsubishi Service Company.

However, if repairs are required onsite at domestic or overseas location, expenses to send an engineer will be solely at the customer's discretion. Mitsubishi shall not be held responsible for any re-commissioning, maintenance, or testing on-site that involves replacement of the failed module.

[Gratis Warranty Term]

The gratis warranty term of the product shall be for one year after the date of purchase or delivery to a designated place. Note that after manufacture and shipment from Mitsubishi, the maximum distribution period shall be six (6) months, and the longest gratis warranty term after manufacturing shall be eighteen (18) months. The gratis warranty term of repair parts shall not exceed the gratis warranty term before repairs.

[Gratis Warranty Range]

- (1) The range shall be limited to normal use within the usage state, usage methods and usage environment, etc., which follow the conditions and precautions, etc., given in the instruction manual, user's manual and caution labels on the product.
- (2) Even within the gratis warranty term, repairs shall be charged for in the following cases.
 1. Failure occurring from inappropriate storage or handling, carelessness or negligence by the user. Failure caused by the user's hardware or software design.
 2. Failure caused by unapproved modifications, etc., to the product by the user.
 3. When the Mitsubishi product is assembled into a user's device, Failure that could have been avoided if functions or structures, judged as necessary in the legal safety measures the user's device is subject to or as necessary by industry standards, had been provided.
 4. Failure that could have been avoided if consumable parts (battery, backlight, fuse, etc.) designated in the instruction manual had been correctly serviced or replaced.
 5. Failure caused by external irresistible forces such as fires or abnormal voltages, and Failure caused by force majeure such as earthquakes, lightning, wind and water damage.
 6. Failure caused by reasons unpredictable by scientific technology standards at time of shipment from Mitsubishi.
 7. Any other failure found not to be the responsibility of Mitsubishi or that admitted not to be so by the user.

2. Onerous repair term after discontinuation of production

- (1) Mitsubishi shall accept onerous product repairs for seven (7) years after production of the product is discontinued. Discontinuation of production shall be notified with Mitsubishi Technical Bulletins, etc.
- (2) Product supply (including repair parts) is not available after production is discontinued.

3. Overseas service

Overseas, repairs shall be accepted by Mitsubishi's local overseas FA Center. Note that the repair conditions at each FA Center may differ.

4. Exclusion of loss in opportunity and secondary loss from warranty liability

Regardless of the gratis warranty term, Mitsubishi shall not be liable for compensation to:

- (1) Damages caused by any cause found not to be the responsibility of Mitsubishi.
- (2) Loss in opportunity, lost profits incurred to the user by Failures of Mitsubishi products.
- (3) Special damages and secondary damages whether foreseeable or not, compensation for accidents, and compensation for damages to products other than Mitsubishi products.
- (4) Replacement by the user, maintenance of on-site equipment, start-up test run and other tasks.

5. Changes in product specifications

The specifications given in the catalogs, manuals or technical documents are subject to change without prior notice.

TRADEMARKS

Ethernet is a registered trademark of Fuji Xerox Co., Ltd. in Japan.

The company names, system names and product names mentioned in this manual are either registered trademarks or trademarks of their respective companies.

In some cases, trademark symbols such as [™] or [®] are not specified in this manual.

SH(NA)-081655ENG-A(1702)MEE

MODEL: R60DAH4-U-IN-E

MODEL CODE: 13JX57

mitsubishi electric corporation

HEAD OFFICE : TOKYO BUILDING, 2-7-3 MARUNOUCHI, CHIYODA-KU, TOKYO 100-8310, JAPAN
NAGOYA WORKS : 1-14, YADA-MINAMI 5-CHOME, HIGASHI-KU, NAGOYA, JAPAN

When exported from Japan, this manual does not require application to the
Ministry of Economy, Trade and Industry for service transaction permission.

Specifications subject to change without notice.